

TRANSLATION OF THE ORIGINAL INSTRUCTIONS

INDEX

1 PRODUCT IDENTIFICATION 3

1.1 APPLICATION, GENERAL FUNCTIONS AND INTENDED USE 3

1.2 NAME AND ADDRESS OF MANUFACTURER OR DISTRIBUTOR..... 3

1.3 DECLARATION OF CONFORMITY TO PRODUCT STANDARDS..... 3

1.4 DESCRIPTION OF THE APPLIANCE 4

2 SYMBOLS USED IN THE MANUAL 4

3 SAFETY PRECAUTIONS AND INSTRUCTIONS 5

3.1 CORRECT INSTALLATION 5

3.2 SAFE USE 6

3.3 CORRECT MAINTENANCE 7

4 PRODUCT CHARACTERISTICS..... 8

4.1 OVERALL DIMENSIONS FOR BUILT-UNDER INSTALLATION 8

4.2 TECHNICAL CHARACTERISTICS..... 9

5 PREPARING THE APPLIANCE FOR USE 10

5.1 POSITIONING AND INSTALLATION 10

5.2 CONNECTION TO THE WATER SUPPLY 11

5.3 DRAIN CONNECTION..... 11

5.4 CONNECTION TO THE ELECTRICITY SUPPLY..... 12

6 FIRST START-UP 13

6.1 FIRST START-UP 13

6.2 PREPARING FOR USE (IMPORTANT) 13

6.3 USING THE WATER SOFTENER (ON MODELS WITH THIS FEATURE ONLY) 13

7 CONTROL PANEL 14

7.1 CONTENTS OF DISPLAY 15

7.2 NOTE ON DISPLAY OF TEMPERATURES..... 15

7.3 PARAMETER PROGRAMMING PROCEDURE (SETUP) 16

7.4 MODIFIABLE PARAMETERS 16

7.5 STARTING THE PERISTALTIC PUMPS IN MANUAL MODE – RAPID FILLING OF DETERGENT AND RINSE AID CIRCUIT. 19

8 MALFUNCTIONS SHOWN ON THE DISPLAY (FOR THE TECHNICIAN) 20

9 INSTRUCTIONS FOR THE USER 22

9.1 BEFORE WASHING 23

9.2 FIRST USE EACH DAY (TANK AND BOILER EMPTY) 24

9.3 PROGRAM CHANGE 25

10 CHOSING THE PROGRAM 25

11 BASKETS PROVIDED 26

12 MAINTENANCE AN CLEANING..... 27

12.1 CLEANING THE FILTER DURING THE DAY 27

12.2 ROUTINE INSPECTION OF THE SPRAY ARM (ONCE A WEEK) 29

12.3 TOTAL PUMP-OUT AT THE END OF THE DAY THE DAY..... 30

12.4 RESIN REGENERATION (FOR MODELS WITH SOFTENER)..... 31

12.5 LENGTHY PERIODS OUT OF USE..... 32

13 TROUBLESHOOTING..... 33

14 MALFUNCTIONS SHOWN ON THE DISPLAY (FOR THE USER)..... 35

NELSON thanks you for choosing one of its products.

This manual is an integral part of the appliance. Take good care of it and keep it to hand throughout the appliance's life cycle, since it contains important information about assembly, safety, use and maintenance. In the event that the appliance is sold on, consign this manual to the new owner.

Before putting the appliance into operation, read all the instructions in this manual carefully to become familiar with the right conditions for the proper use of your professional dishwasher.

1 PRODUCT IDENTIFICATION

1.1 Application, general functions and intended use

This dishwasher is intended for professional use in the restaurant and institutional catering sector and complies with the relevant safety regulations. However, misuse may cause injury and/or damage, and therefore the dishwasher must only be used by suitably trained staff.

This dishwasher is designed for use in non-mobile premises and is intended only for washing cutlery and dishes (plates, ovenware, cups, glasses, bowls, etc.) stable at the temperature and humidity generated by the appliance. Any other type of use is not permitted and may be dangerous.

Persons whose physical, sensory or mental capabilities, inexperience or lack of knowledge render them unable to use the dishwasher safely must not use it without the supervision and guidance of a responsible person.

The manufacturer is not liable for any injury or damage caused by failure to comply with the instructions given in this manual, misuse, tampering with even a single part of the appliance, or the use of non-genuine spare parts.

1.2 Name and address of manufacturer or distributor

Nelson Dish & Glasswashing Machines Unit 1 Rowley Industrial Park Roslin Road Acton
LONDON W3 8BH 020 8993 6198 Our whole product offering can be viewed at:
www.nelsonwash.co.uk International customers, please contact your local Nelson distributor.

1.3 Declaration of conformity to product standards

This appliance complies with the relevant safety regulations and conforms to the requirements of directives 2006/42/EC and 2004/108/EC.

The dishwasher is also marked in compliance with European Directive 2002/96/EC on Waste Electrical and Electronic Equipment (WEEE).



For information on the treatment, recovery and recycling of this product, contact the local authority, domestic waste collection service, or your authorized reseller.

Make sure that this product is scrapped correctly to safeguard the environment and health.

1.4 Description of the appliance

U	COVER (TOP)	
D	DISPLAY AND CONTROL PANEL	
A	FRONT LOADING/UNLOADING DOOR	
V	SERVICE COMPARTMENT	
F	ADJUSTABLE FEET	

2 SYMBOLS USED IN THE MANUAL

	This symbol instructs the user to read the instructions in the manual with care.
	This symbol appears next to information important for the safety of people and the appliance.
	This symbol is applied to some parts which contain live electrical components and indicates the risk of electric shock.
	This symbol is applied close to the terminal used to earth the appliance's electrical system.
	This symbol appears next to important information. Read the instructions provided with care and comply with the procedures and rules described.
	This symbol appears next to information and technical instructions intended for the qualified staff who are to install, commission and test the appliance and carry out any repairs.
	This symbol indicates that at the end of its working life, the appliance must be consigned to a disposal plant for recovery and recycling in accordance with the relevant legislation in the country of installation. Contact a specialist centre for disposal.

3 SAFETY PRECAUTIONS AND INSTRUCTIONS

The precautions and instructions below contain important information and must be read with care. The manufacturer does not accept responsibility for damage caused by failure to comply with the safety precautions and instructions.

3.1 Correct installation

- The dishwasher must be installed by an authorised technician.
- When handling and installing the dishwasher, always wear the most suitable personal protection equipment (PPE) for the task in hand.
- Do not install a dishwasher which has been damaged during transport. If in doubt, consult your dealer.
- If the power supply cable is damaged, do not run the dishwasher.
- Do not install the dishwasher in areas subject to freezing temperatures or in atmospheres with explosion risk (ATEX).
- Any accessories may only be installed on the appliance if authorised by the manufacturer.
- Do not install the dishwasher next to appliances which irradiate strong heat (e.g. gas burners, stoves, etc.) since they could cause damage.
- If the dishwasher is installed above the ground, make sure that the stand and dishwasher are secured properly and do not constitute a hazard.
- Electrical safety is only ensured if the dishwasher is connected to an earth conductor compliant with the relevant electrical regulations. If in doubt, have the system inspected by a qualified electrician.
- A circuit breaker and overcurrent protection device (magnetothermal switch or fuses) must be installed in an easily accessible position on the dishwasher's power supply line. This device must only serve the dishwasher and must be suitable for its rated electrical characteristics.
- Do not connect the dishwasher to the electrical mains by means of adapters or extensions, since they do not guarantee the safety required.
- If the dishwasher is connected to the electrical mains by means of a plug, it must be of the same type as the power socket, suitable for the appliance's rated electrical characteristics and compliant with the relevant national regulations on electrical systems. The power plug must be easily accessible after the appliance has been installed.
- Only use new hoses for connection to the water supply. Old hoses or hoses salvaged from previous installations must not be used.
- The drain connection must be made in accordance with the relevant national regulations. Substandard connections may cause flowback and in some cases pollution.

3.2 Safe use

- The staff assigned to use the dishwasher must be suitably trained and instructed.
- The appliance is not suitable for use by juveniles or persons with reduced physical, sensorial or mental capacities, or those without the necessary knowledge and experience. Such persons may only use the appliance under the supervision of a person responsible for their safety.
- Do not leave the dishwasher door open. Risk of tripping or injury against the edges of the door.
- Do not sit or lean on the open door. This may tip over or damage the appliance.
- The water inside the dishwasher is not drinkable.
- Do not use the dishwasher for washing or soaking foods.
- Do not use the water inside the dishwasher for defrosting foods, even if they are in airtight containers.
- When using the dishwasher, remember that the plates are very hot at the end of a wash cycle.
- Knives and pointed kitchen equipment must be placed in the basket with their tips downwards, or horizontally, taking care not to allow them to protrude from the basket
- The dishwasher is only intended for use with water and detergents suitable for washing in professional dishwashers. The use of other products may damage both the dishes and the appliance.
- Do not operate the dishwasher with organic solvents or flammable liquids. Never load dishes dirty with ash, wax or paint.
- When handling detergents comply strictly with the instructions provided by the detergent producer.
- Always keep the detergent safety datasheets within reach so that the operator can consult them easily if necessary.
- Swallowing or inhaling detergents may cause serious injury to the nose, mouth and throat. If detergent has been inhaled or swallowed, seek medical advice immediately.

3.3 Correct maintenance

- Do not spray jets of water or steam directly at the appliance since they could cause infiltrations of liquids, damaging for the appliance and hazardous for the operator.
- Before performing any maintenance procedure on the appliance disconnect it from the mains electricity supply. Touching live electrical components, even accidentally, may be very dangerous.
- Never open the dishwasher's case. Electric shock hazard. Only the authorised technician may access the internal parts of the dishwasher.
- The dishwasher may only be repaired by the authorised service organisation. Substandard repairs may cause damage or danger for the user.
- No alterations or changes of any kind to the appliance's electrical circuits or mechanical structure are permitted. The manufacturer declines all responsibility for damage arising from unauthorised alterations.
- Replace any faulty parts only with genuine spare parts. The manufacturer declines all liability for damage resulting from the use of non-genuine spare parts.
- The power supply cable, if fitted, must be replaced by the manufacturer or an authorised service centre in accordance with the technical data specified on the wiring diagram supplied with the appliance, to prevent all risks.

4 PRODUCT CHARACTERISTICS

4.1 Overall dimensions for built-under installation

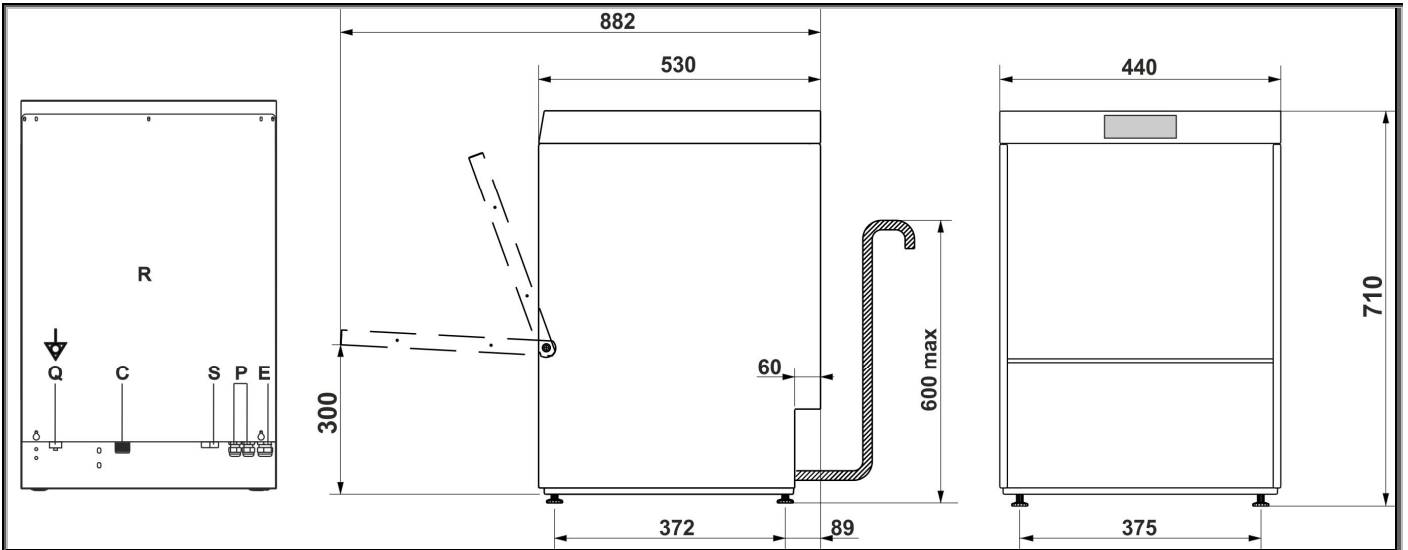

R	LOWER BACK PANEL	E	ELECTRICITY SUPPLY CABLE
C	FILLER HOSE	P	PERISTALTIC HOSES
Q ↓	EARTH TERMINAL	S	DRAIN HOSE
T	EXTERNAL DISPENSER POWER CABLE ENTRY POINT		

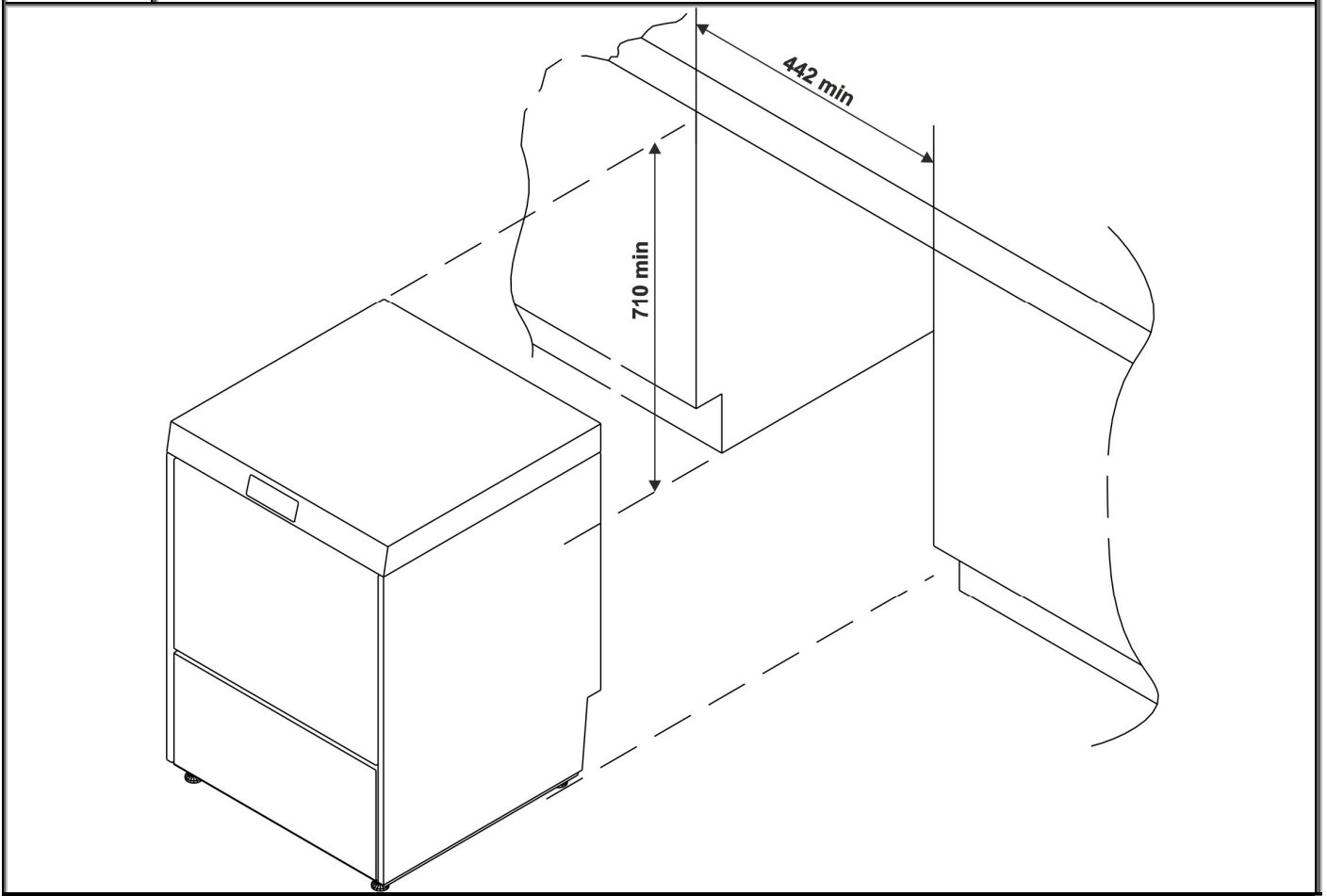

4.2 Technical characteristics

Electricity supply	-	See technical data plate and electrical wiring diagram supplied with the appliance
Intake water pressure	-	
Intake water temperature	-	
Use	-	Indoor
Max. working altitude	m	2000
Working ambient temperature	°C	10 - 35
Relative humidity		80% for temperatures up to 25°C with linear decrease to 50% at the temperature of 35°C
Intake water hardness (models with softener)	°f	≤ 60
Intake water hardness (models without softener)	°f	≤ 15
Water intake flow rate (models with rinsing pump)	L/min	min 6
Water intake flow rate (models without rinsing pump)	L/min	min 12
Intake hose connection	-	threaded 3/4 "
Drain minimum diameter	mm	25
Drain height (above appliance installation surface)	mm	max 600
Rinse cycle water consumption	L	2.3
Boiler capacity	L	4
Tank capacity	L	8
Noise level	LpA	< 60 dB(A)
Degree of protection	IPX	4
Net weight	kg	~ 42
Power supply cable type	◀HAR▶	H07RN-F

5 PREPARING THE APPLIANCE FOR USE

Convey the dishwasher to the installation site, remove the packaging and check the appliance and components for damage; any damage found must be reported to the transporter in writing. The packaging components (plastic bags, expanded polystyrene, nails, etc.) must not be left within reach of children and pets since they are potentially dangerous. All packaging materials used are environment-friendly. They can be kept without constituting any hazard, or may be disposed of at a specialist waste disposal centre. The plastic components suitable for recycling are marked as follows:

PE - polyethylene: external packaging film, bag containing the instructions, protective bags.

PP - polypropylene: straps used to close the packaging.

PS - expanded polystyrene: corner guards, top of packaging.

Wooden and cardboard components can be disposed of in accordance with the local regulations.



All operations described in this section must be carried out and/or checked by the qualified staff who install and commission the dishwasher.

5.1 Positioning and installation

Place the dishwasher in the chosen point and remove the protective film. Level the dishwasher (with the aid of a spirit level) on its four feet, adjusting them to ensure that it is stable. If the dishwasher is installed above the ground, make sure that the stand and dishwasher are secured properly and do not constitute a hazard.



The systems and premises in which the dishwasher is installed must comply with the relevant regulations.



If the dishwasher is installed next to another appliance, also check the recommendations provided by the manufacturer of the adjacent appliance.



Installations other than those described must first be approved by the manufacturer.



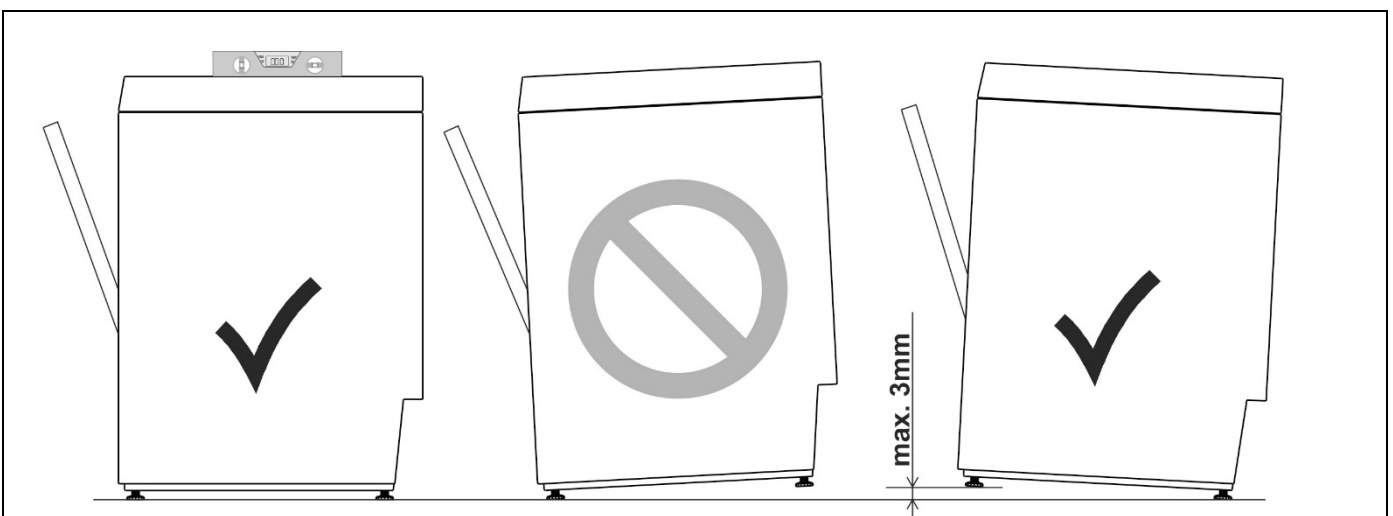

Use only professional furnishings and units in the vicinity of the dishwasher. Any other types of furnishing may be damaged.



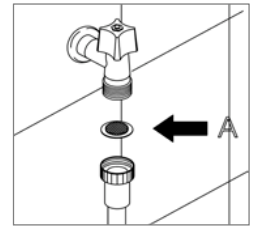

5.2 Connection to the water supply

Check that the intake water pressure, flow rate and temperature are as stated in the dishwasher's technical characteristics. If the dynamic pressure exceeds the limit stated in the technical characteristics, a pressure reducer must be installed. If the pressure is lower, it might be necessary to fit a special pump to ensure optimal performance. Connect the water intake hose to a connector with 3/4" gas threaded fitting, inserting the filter "A" provided. The tap must be easily accessible after installation of the appliance.



- 

Only use new hoses for connection to the water supply. Old hoses or hoses salvaged from previous installations must not be used.
- 

If the water supply system has been unused for a long time or if work has been done on it, before connecting the appliance's intake hose run the water to flush the air and dirt from the pipes.
- 

FOR MODELS WITH A WATER SOFTENER
 An "approved" double check valve or some other no less effective device providing backflow prevention protection to at least fluid category two shall be fitted at the point of connection between the water supply and the fitting or appliance.
FOR MODELS WITHOUT A WATER SOFTENER
 An "approved" single check valve or some other no less effective device providing backflow prevention protection to at least fluid category two shall be fitted at the point of connection between the water supply and the fitting or appliance.

5.3 Drain connection

The dishwasher is fitted with a drain pump and can operate with drain connections on the floor or wall. Before connecting the hose, check that the diameter and height of the wall drain connection are as stated in the dishwasher's technical characteristics. When connecting the dishwasher's drain hose, take care to avoid kinks, sharp bends or crushing. Since the drain water temperature can be very high, the end of the drain hose must be fixed to the drain connection using the hose clamps provided.

- 

The drain connection must be made in accordance with the relevant national regulations. Substandard connections may cause flowback and in some cases pollution.
- 

No extensions must be added to the drain hose supplied with the appliance. Any extensions might cause drainage problems.

5.4 Connection to the electricity supply

The dishwasher must be connected to the electrical system by authorised, skilled staff, in accordance with the relevant regulations. Also comply with the technical instructions for the connection provided with the appliance. The dishwasher's rated electrical characteristics are provided on its technical data plate. A circuit breaker with contact gap rated for category II overvoltage and an overcurrent protection device (magnetothermal switch or fuses) must be installed in an easily accessible position on the dishwasher's power supply line. These devices must only serve the dishwasher and must be suitable for its rated electrical characteristics. The electrical protection devices must undergo a functional test before the dishwasher is put into operation. If the dishwasher is connected to the electrical mains by means of a plug, it must be of the same type as the power socket, suitable for the appliance's rated electrical characteristics and compliant with the relevant national regulations. The power plug must be easily accessible after the appliance has been installed.



Electrical safety is only ensured if the dishwasher is connected to an earth conductor compliant with the relevant electrical regulations. If in doubt, have the system inspected by a qualified electrician.



Do not connect the dishwasher to the electrical mains by means of adapters or extensions, since they may cause dangerous overheating.



Connect the appliance to the earth system. The earth connection terminal is low down on the back of the appliance and is marked with the ∇ symbol.



The dishwasher is always powered up unless the master switch is turned off or, on appliances with power plug, the plug is disconnected.

6 FIRST START-UP

6.1 First start-up

The electrical protection system must undergo a functional test before the appliance is put into operation. The appliance must be installed and/or inspected by qualified staff, who will start it up for the first time and provide the relevant operating instructions.

6.2 Preparing for use (Important)

The rinse aid dispenser is fitted on all models, the detergent dispenser only on some.

If both dispensers are present put the external detergent and rinse aid containers in place and insert the respective intake hoses on the rear of the appliance into them. Red hose: detergent, blue hose: rinse aid.

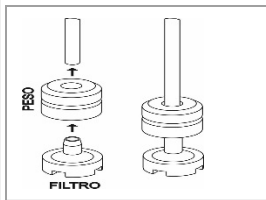

Before inserting the hoses into the containers, fit the weights (needed to ensure that they always draw in liquid from the bottoms of the containers) and the filters onto their ends as shown. If the detergent dispenser is not factory-fitted, it can be retrofitted after ordering the relative kit.

! IMPORTANT: !

Whenever the type of detergent or rinse aid is changed, it is **ABSOLUTELY ESSENTIAL** to flush out the peristaltic pumps by placing the external intake pipes in water for a few cycles. Always use only products specifically recommended for use in a professional dishwasher. Failure to comply with this recommendation leads to **forfeiture of the warranty** entitlement on the appliance's water system. Replacement of the **internal tube** of the detergent and rinse aid peristaltic pumps is **recommended every 12 months or 15.000 wash cycles**, by the After-Sales Service.

6.3 Using the water softener (on models with this feature only)



The quantity of lime in the water (which indicates its hardness) causes whitish marks on dry dishes and dishes also tend to lose their shine over time. The dishwasher is equipped with an automatic water softener which removes the substances that cause hardness from the water with the aid of regenerating salt.



The first time the dishwasher is used, a litre of water must be poured into the tank with the salt. Whenever the tank is filled, always take care to ensure that the cap is firmly closed. The mixture of water and detergent must not get into the salt tank, as this would impair operation of the regeneration system. In this case warranty cover will be forfeited.

7 CONTROL PANEL

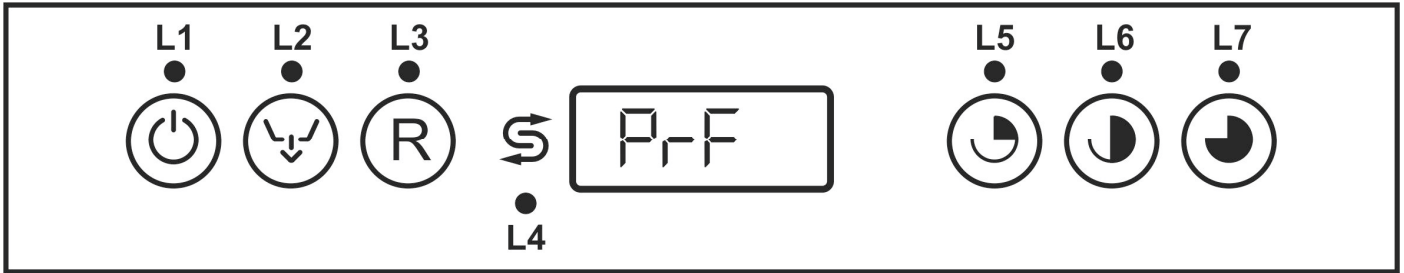









Key to Symbols

	On/off button
	Total pump-out (tank -boiler) button
	Regeneration button (only if softener is fitted)
	Regenerating salt symbol (only if softener is fitted)
	Short programme button
	Medium programme button
	Long programme button
L1	Appliance on Led
L2	Drainage Led
L3	Resin regeneration Led (only if softener is fitted)
L4	No salt Led (only if softener is fitted)
L5	Short programme Led
L6	Medium programme Led
L7	Long programme Led

Key to messages on display

CLOSE	Close the hood
FILL	Machine preparing for cycle
End	End of operation requested
PrF 400/500/CAP	Machine model (viewed when the machine is started with master switch)
F x xx r xxx	Version/revision of the installed firmware. (viewed when the machine is started with master switch, after the model code)
UnLoad	Pump-out
OFF	Energized machine OFF

Using the buttons

Button	Short press	Pressed for 2"	Pressed for 5"	Long press, release, press again
	Display temperatures Boiler and tank	On/OF	-----	Hood open and machine OFF . Long press >>> display reads "- -" >>> release and press again: Access Setup Menu (1)
	Scroll through Setup options (2)	-----	Total pump-out (tank+boiler).	-----
	-----	-----	Start Regeneration	-----
	Set Short Programme	Start Short Programme	-----	-----
	Set Medium Programme	Start Medium Programme	-----	-----
	Set Long Programme	Start Long Programme	-----	-----
	Set P0 (Empty tank)	-----	Start P0 Hood closed	-----
	-----	Peristaltic pumps in Manual mode to prime pipes	-----	Reset to DEFAULT parameters (1) Technician user only

1) Restores the default parameters, for new settings see point (6.3)

A series of operations can be carried out when the dishwasher is first installed to customise it to the user's requirements.

7.1 Contents of display

The display provides the following information:

- Machine off but energized: **OFF**
- Machine on and ready for use: **End/P1-P2-OP3**
- Wash phase: |||||
- Programming phase: See parameter programming section
- Error message: See error messages section







7.2 Note on display of temperatures

Temperatures shown on the display might not indicate the actual temperature in the tank and/or boiler during heating wait about 1' after the heating elements switch off to see the real temperature.

7.3 Parameter programming procedure (setup)

Temperatures shown on the display might not indicate the actual temperature in the tank and/or boiler during heating wait about 1' after the heating elements switch off to see the real temperature.

To modify the parameters, proceed as follows starting with the appliance in "OF" status with the hood open.

- 1) Switch the appliance using the On/OF button
- 2) Press and hold the button  until the display shows "- -", release and press again.
- 3) Press the pump-out button  to scroll through the parameters for modification
- 4) Modify the parameter by pressing button P1 
- 5) During setup operations, the description and value of the parameter alternate on the display.
- 6) Select the other parameters for modification in the same way and proceed as described above
- 7) To exit the setup menu press and hold  until the display shows "OFF", press P2  or P3  or wait at least 3 minutes without pressing any key; in this way the machine automatically exits the setup menu.

7.4 Modifiable parameters

This table lists the model choice or programme and temperature option parameters.

Display	Settings available	Description
°b *	From 85° to 71°	Boiler temperature
°t *	From 62° to 50°	Tank temperature
ri	0 – 2 gr/lit (in steps of 0,1)	Rinse aid batching
dE	0-10 gr/lit (in steps of 0,2)	Detergent batching
St	On - OF	Auto-start: washing programme starts when hood is closed On enabled OF disabled
HA	H0 – H6	Water hardness setting
Er	On-OF	Prolonged rinse at the end of the washing cycle (+8").
CL	On-OF	Clean water cycle. On enabled OF disabled
TS	On - OF	Thermostop On enabled OF disabled
Fi	FS-EC	Starting the machine in FAST or ECO mode (models without rinsing pump only)
Sr	-	Access Service menu (for Authorised Engineer only)

* The set temperatures refer exclusively to the wash cycles. During other phases (e.g. FILL, regenerate etc.), other values may appear on the display.

Adjusting detergent and rinse aid dispensing (optional if installed)

Rinse aid – Grams/liter dosage (depends on model) – The display Reads “ri”

		<p>Every time is pressed, the value increases of 0,1 g/l up to a max. of 2 g/l.</p> <p>Default: 1,2 g/l.</p>
--	--	--

Detergent – Grams/liter dosage (depends on model) – The display Reads “dE”

		<p>Every time is pressed, the value increases of 0,2 g/l up to a max. of 10 g/l.</p> <p>Default: 2 g/l.</p>
--	--	---

Regeneration frequency setup (models with softener)

	<p>Default value: H03; modify the parameter to suit the mains water hardness.</p> <p>At first use, the salt tank has to be filled. It is subsequently sufficient simply to fill up with regenerating salt when necessary.</p>
--	--

	<p>With values over 60°dF / 33°dH an external water treatment device must be used and the regeneration frequency must be set at H0</p>
--	--

Mains water hardness setting table

After a number of washing cycles corresponding to the set water hardness has been started.

Ppm-mg/l	Hardness (°dH German degrees)	Hardness (°dF French degrees)	Setting level
Regeneration off			HA: 00
150	8.5	15	HA: 01
200	11	20	HA: 02
300	17	30	HA: 03 default
400	22.5	40	HA: 04
500	28	50	HA: 05
600	33.5	60	HA: 06

Extra rinse option (long rinse) – display reads “Er”



Rinse is 8" longer than the standard in every washing cycle.

Press  to enable **(On)**/disable **(OF)**

"Clean water cycle" option – display reads “CL”



With this option clean water is used for every washing. At each cycle, the washing water is completely drained and it is replaced with clean water from rinsing.

Press  to enable **(On)**/disable **(OF)**

Thermostop option – display reads “tS”



“on” = **the minimum temperature of rinse** as set, independently from the intake water temperature, the nominal duration of cycle may be extended by a few seconds.

“off” = **the minimum temperature of rinse** may be a few degrees lower than the set one, if hot intake water is not used.

Press  to enable (On)/disable (OF)



If the thermostop device is set “off” the rinsing °t are no longer monitored and the user is responsible for ensuring that the minimum correct °t are maintained for the tank and boiler. It is particularly important to check the intake water temperature.

Also refer to the insufficient washing/drying /foam in tank point of the “troubleshooting” section : restore °t Stop ON and/or connect the appliance to a hot water supply.

Fast/eco starting option – display reads “tS”





Fast (FS): it allows to start the machine in less time than the standard; it involves a greater water consumption at the first start.

Eco starting (EC): the machine starts in standard time, without any additional water consumption.

Press  to enable (On)/disable (OF)

7.5 Starting the peristaltic pumps in manual mode – rapid filling of detergent and rinse aid circuit.

Energized dishwasher and full tank: press for 5 seconds buttons **P2**  + **P3**  simultaneously.

The peristaltic pumps work until **P1** or **P2** are pressed again; during the procedure the indicator lights stay on and the display shows “rd”. The rinse aid circuit is filled in 7 minutes, the detergent circuit is filled in 2 minutes.

Since the pumps work at the same time, only the rinse aid (blue tube in the rinse aid jerrycan) must be withdrawn for 5 minutes, then the detergent (red tube in the detergent jerrycan) is withdrawn too for the last two minutes.

8 MALFUNCTIONS SHOWN ON THE DISPLAY (FOR THE TECHNICIAN)

The dishwasher is able to identify a number of malfunctions and show them on the display. If the problem persists after the dishwasher has been switched off and back on, proceed as described below:

Er 04	Tank temperature probe malfunction	Tank temperature probe disconnected or not working.
Er 05	Tank water filling malfunction	<ul style="list-style-type: none"> - The tank wasn't filled in the expected time: check the water supply tap, the dynamic supply pressure, cleanliness of the inlet water filter, cleanliness of the rinse nozzles, any damage of the water charging hose. If the problem still occurs during the "FILL": - Work level tank pressure switch damaged (it always detects "empty": check if the tank safety pressure switch starts operating). - Leakage from the tube connected to the air trap; if the problem is not solved, it occurs during the work program. - vent valve of the drain pipe obstructed with dirt: with siphonage, the tank gets completely empty at the end of a washing program.
Er 06	Water pump-out malfunction	<p>Check:</p> <ul style="list-style-type: none"> - filter cleanliness; obstructions, bending and narrowing of the drain pipe. - possible obstructions of the drain pump (blocked with a foreign body). <p>In case the problem is not solved, please contact the After-Sales Service.</p>
Er 23	Boiler does not heat up as expected.	<p>The problem might occur because water is continually entering the tank (the causes are as for "Er 05" – see above) If the boiler heating element is damaged, this might be due to operation with no water in the boiler - the pressure switch is indicating full even with the boiler empty: - damaged boiler heating element – contactor failure - open on boiler safety thermostat side. - boiler temperature probe faulty or incorrectly positioned - motherboard relay failure, Important: If the boiler heating element is damaged, this might be due to operation with no water in the boiler, pressure switch continues to give full reading even with boiler empty: check boiler air trap and/or relative pressure switch and replace if necessary.</p>
Er 24	Boiler temperature probe malfunction	Boiler temperature probe disconnected or not working

<p>Er 25</p>	<p>Boiler water filling malfunction</p>	<p>The boiler wasn't filled in the expected time: check the water supply tap, the dynamic supply pressure, cleanliness of the inlet water filter, any damage of the water charging hose, or check the following in this order:</p> <ul style="list-style-type: none"> - faulty boiler pressure switch (it always detects "empty"), - leakage or unbinding of the tube (water runs inside the tube) - menu service wrong setting "rP"
<p>Er 26</p>	<p>Boiler emptying malfunction</p>	<ul style="list-style-type: none"> - check cleanliness of the rinse nozzles - faulty boiler pressure switch (it always detects "full") - leakage or unbinding of the tube (water runs inside the tube) - rinsing pump malfunction (if present)
<p>Er 27</p>	<p>Boiler emptying malfunction – with tank full Or boiler full signal on models without rinsing pump</p>	<p>Faulty boiler pressure switch (it always detects "full"). If this occurs in models without rinsing pump, the boiler pressure switch is wrongly detected: check settings in the service menu on entry "rP"</p> <p>"rp" = on for models with rinsing pump "rp" = of for models without rinsing pump</p>

9 INSTRUCTIONS FOR THE USER

Control panel

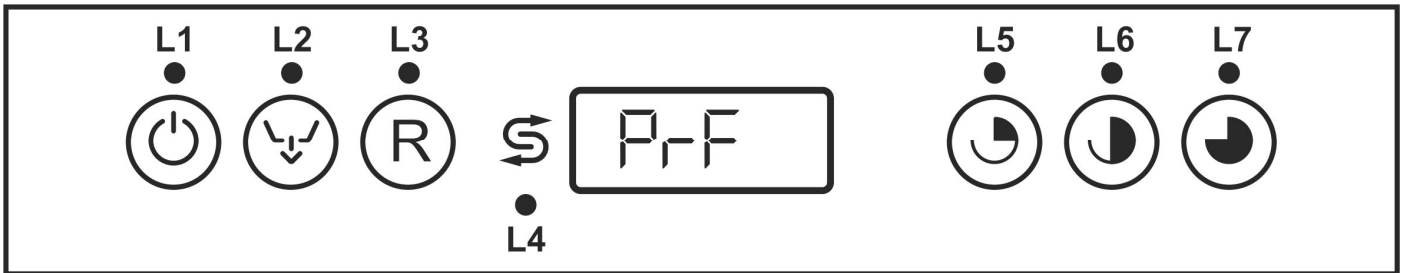







Key to Symbols

	On/off button
	Total pump-out (tank -boiler) button
	Regeneration button (only if softener is fitted)
	Regenerating salt symbol (only if softener is fitted)
	Short programme button
	Medium programme button
	Long programme button
L1	Appliance on Led
L2	Drainage Led
L3	Resin regeneration Led (only if softener is fitted)
L4	No salt Led (only if softener is fitted)
L5	Short programme Led
L6	Medium programme Led
L7	Long programme Led



Key to messages on display

CLOSE	Close the hood
FILL	Machine preparing for cycle
End	End of operation requested
PrF 400/500/CAP	Appliance model (displayed when the appliance is switched on with the master switch).
UnLoad	Pump-out
OFF	Energized machine OFF

Using the buttons





Button	Short press	Pressed for 2"	Pressed for 5"
	Display of temperatures in Boiler (L3) and tank (L1)	On/OF	
			Start total drain (tank + boiler)
		Start Regeneration	
		Start Short Programme	
		Start Medium Programme	
		Start Long Programme	
	Set P0		Start programme P0: emptying of tank to clean filters. Switch off and back on to allow reuse.

9.1 Before washing

	Use only detergents and rinse aids for industrial dishwashers. Do not use detergents intended for hand washing. We recommend the use of specially products developed for this dishwasher.
	When topping up the tanks, take care not to swap the products; this might damage the dishwasher and cause malfunctions.

Do not mix different detergents; this would damage the dispenser device. **Failure to comply** with this recommendation leads to **forfeiture of the warranty** entitlement on the appliance's water system. Industrial dishwasher detergents may cause serious irritation. Comply carefully with the instructions provided by the detergent producer on the pack.

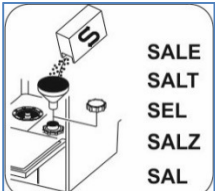
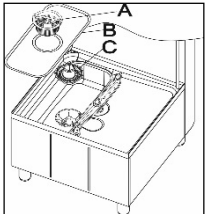



Check

Turn on the mains water tap (user)	The level of detergent and rinse aid in the containers.	That there is regenerating salt in the relative container (if fitted).	That the filters are in place, the spray arms rotate, and there are no foreign bodies in the dishwasher.	Switch on the master switch (user): the decimal points of both digits appear on the display.
		 SALE SALT SEL SALZ SAL		 ON-OFF

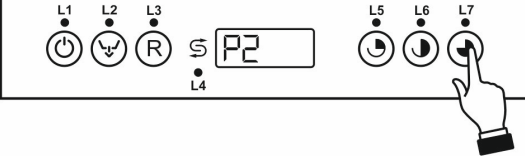
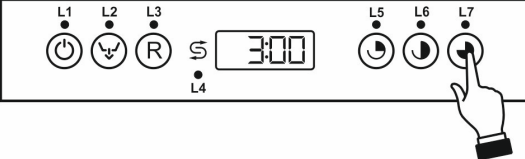

9.2 First use each day (tank and boiler empty)

	<p>Hood closed and master switch on ON:</p> <p>Press and hold for 2/3 seconds, Leds ON/OFF light up and the firmware version and e revision are displayed (F xxx r xxx...); FILL is displayed afterwards.</p>
	<p>Tank filling starts. When the tank is full the display reads "End" alternating with the last running program (End/P1).</p>
	<p>Load the dishes. Close the door.</p>
	<p>Select the program required by holding down one of the three buttons required for about 2"; the Led of the program flashes. During the wash, a series of vertical bars on display indicate the progress of the selected program.</p>
	<p>When the program is over, the program led stops flashing and stays on, the display alternates the run program and "End" (ex. P2/End).</p>
	<p>Unload the dishes. When the dishwasher is closed again, the system offers the last program run.</p>

9.3 Program change

	<p>If the master switch is not turned off, the appliance sets on the last programme performed. To change the program, press the button of the desired program, the led flashes and the display reads the program duration.</p>
	<p>To confirm hold down for about 2". The led flashes and the wash program starts.</p>
<p>If a programme is already running, it can be changed by first switching the appliance to pause status (by pressing one of the    buttons for 2") and then selecting the programme required.</p>	

10 CHOSING THE PROGRAM

SYMBOL	PROGRAM	TYPE OF DIRT	DURATION (*)
	Short	Glasses and cups	1'30"
	Medium	Glasses, cups and plates with light dirt	2' 30"
	Long	Very dirty dishes and cutlery	4'

(*) The cycle duration stated above is guaranteed if the water intake temperature is as stated and recommended in the "TECHNICAL DATA" table, and in all cases refers to the first cycle performed. For repeated cycles, operating conditions may vary from installation to installation. If the dishwasher is supplied with cold water, the cycle duration might increase depending on the intake water temperature and the "thermostop" setting.

	<p>If the hood is opened when a program is in progress, the program is interrupted; when the hood is closed again the program must be restarted.</p> <p>Power failure. If the hood is open when power is restored, the display reads "CLOSE" and "t" flashes; the heating element stays off for the user's safety, in order to avoid the risk of burns. Close the hood to resume heating the water in the tank.</p>
---	--

11 BASKETS PROVIDED

The shape and material of the baskets provided with the dishwasher depend on the purchased model. Extra baskets can be purchased through the After-Sale Service. The following images are indicative.

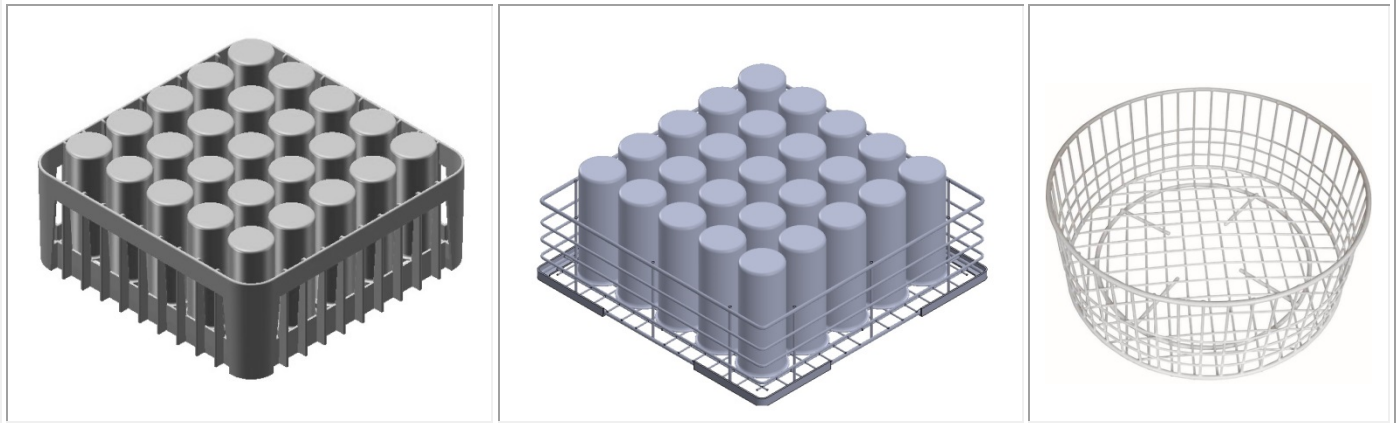

Glasses: Place the glasses downwards.



Cutlery

Use the dedicated basket. Place the cutlery randomly, preferably with the handle downwards, using caution to avoid injuries due to prongs of forks and blades of knives.

12 MAINTENANCE AN CLEANING

We recommend regular servicing by an authorised service centre at least once a year, to guarantee optimal performance at all times.

Consumables (e.g. peristaltic pump hoses) and/or parts subject to wear and tear must be replaced with genuine parts.

N.B.: the manufacturer accepts no liability for wilful damage or damage deriving from carelessness, neglect, failure to comply with instructions, regulations and standards or incorrect connections, which lead to forfeiture of warranty cover.

	The dishwasher has IPX4 protection, but the use of direct water jets for cleaning is forbidden .
--	--

	Clean the outside of the appliance with a damp cloth and neutral soap, rinsing and drying thoroughly.
--	---

12.1 Cleaning the filter during the day

	<p>Drain tank (P0) Press buttons P1 + P2 simultaneously to start draining the water from the tank. This takes approximately 1 minute.</p>
	<p>When the water has been drained, FILL flashing on the display and the filters can be cleaned. Next, press any button to start the FILL function (fill and heat) (FILL stops flashing and remains lit).</p>

The filter group is made of 2 or 3 filtering elements, according to the model.

Procedure to disassemble filters made of 3 filtering elements:

- a- Unfasten and remove the lower spray arm
- b- Lift and remove the two rectangular filters
- c- Rotate filter "C", lift it and separate it extracting the central part "D"

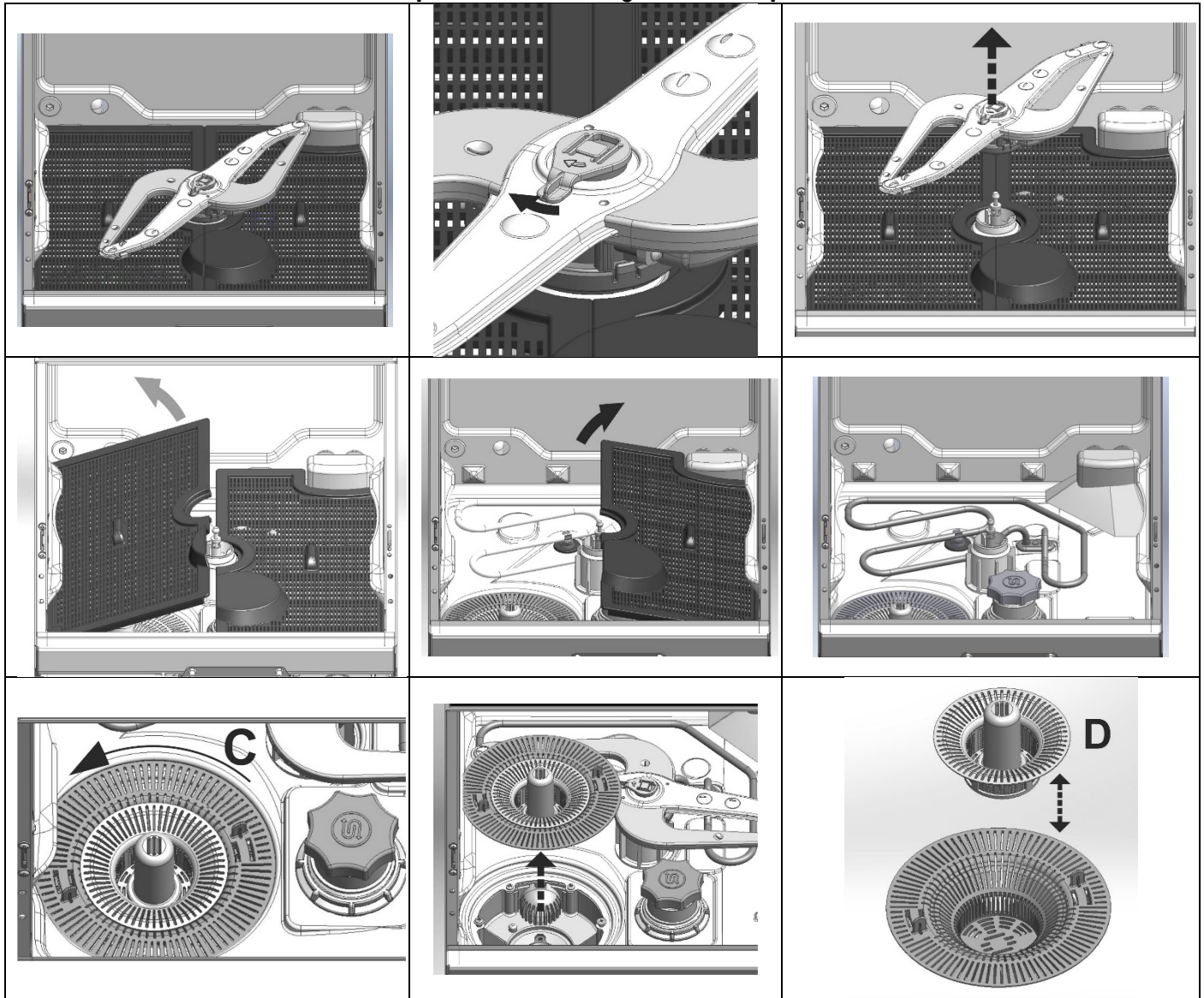

Procedure to disassemble the filters made of 2 filtering elements:
it is not necessary to remove the lower spray arm.

a- Rotate filter "C", lift it and separate it by extracting the central part "D"

Filter "C" can have different depths, according to the model.

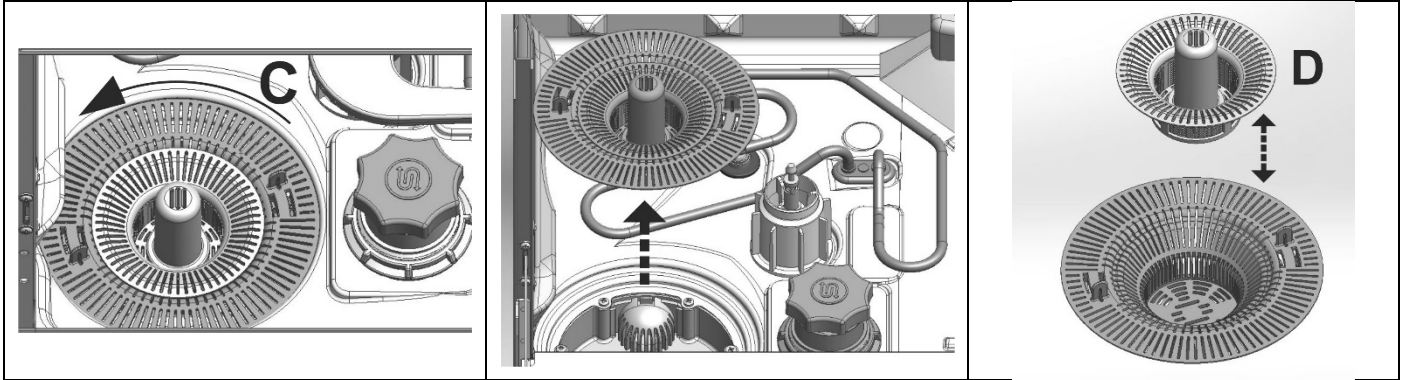

When removing the filters, do not let the coarse residues fall into the basin under the filters; clean and rinse them thoroughly, then re-insert them correctly; do not use sharp or pointed objects.

If present, clean any limescale deposit to prevent accumulation;

- When not in use, leave the door ajar if possible;

Clean the surfaces with a damp cloth accurately and frequently; use neutral, non-abrasive detergents, which do not contain chlorine based substances, or products that corrode and damage stainless steel.

Do not use the products described above to clean the floor under the dishwasher or near it, to prevent the steam or drops to damage the steel surfaces.

IMPORTANT:the dishwasher automatically starts the "P0" program at the beginning of the day, if there is water left in the tank and this is under the temperature of 40°C.

12.2 Routine inspection of the spray arm (once a week)

Remove the inferior and superior spray arms. Releasing the retaining element "R" is enough to remove them. Clean the spray arms with clean flowing water, **do not use tools which may cause damages.** Reassemble the spray arms carefully.

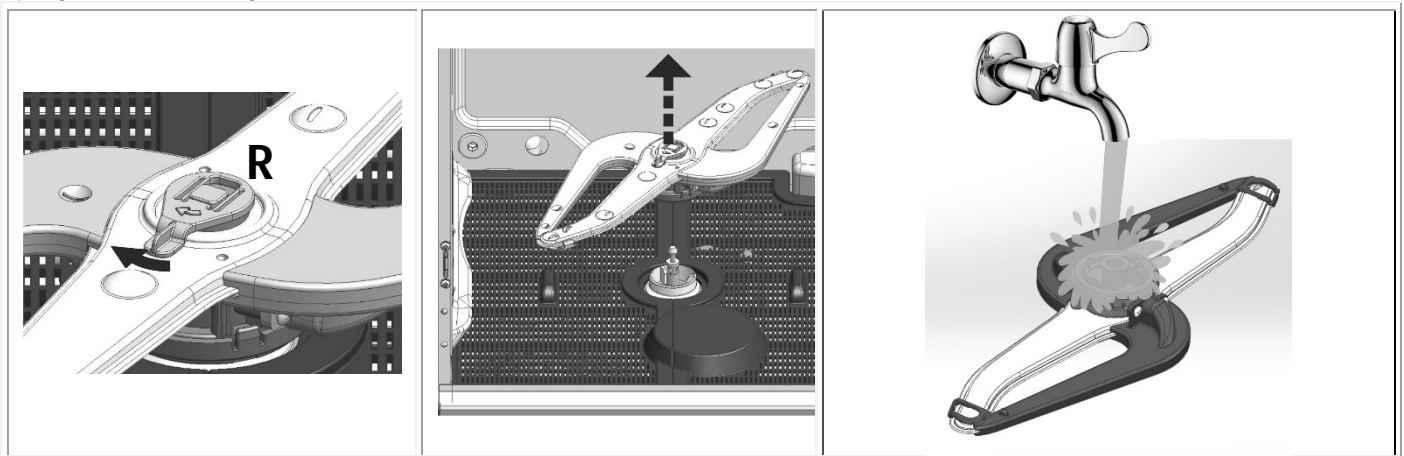

12.3 Total pump-out at the end of the day the day

This is a drain and self-cleaning program with automatic shutdown.

<p>The diagram shows a control panel with seven indicator lights labeled L1 through L7. L1 is a power button, L2 is a pump-out button (a circle with a downward arrow and a curved arrow), L3 is a reset button (a circle with 'R'), L4 is a small square button, L5, L6, and L7 are circular buttons with arrows. A hand is shown pressing the L2 button. The digital display shows the characters 'UnLo'.</p>	<p>Press the pump-out button  for about 5", the Led flashes and the pump-out and automatic tank cleaning phase starts. The word "UnLoad" scrolls across the display. If the Led does not flash, the program has not been started and the boiler heating element is not on.</p>
<p>The diagram shows the same control panel as above. The digital display now shows 'OFF'. The L2 button is no longer being pressed.</p>	<p>When pump-out is complete the appliance switches off.</p>
<p>After a total pump-out the filters should be cleaned as described in the relevant point.</p>	

 **Never switch the dishwasher off with water in the tank; always pump out first.**

12.4 Resin regeneration (for models with softener)

The frequency with which the resin regeneration cycle (**regenerate**) has to be carried out depends on the number of washes performed and the hardness of the mains water.

The dishwasher indicates that it needs to be carried out when **L3** on the **R** button flashes. This does not prevent you from carrying out further wash cycles, but it is recommended that you carry out a regeneration cycle as soon as possible.

Once it has been started, the regeneration cycle cannot be interrupted. Even if you open the door or switch off the power, it will still need to be completed in order to use the dishwasher.

This can be done in two ways:

	<p>1) ON REQUEST Press the R button until rE appears on the display. Regeneration starts and L3 flashes more quickly. Towards the end of this phase, L3 switches off and the program progress bars appear, then FILL flashes.</p>
	<p>Press any button to start the FILL function (it stops flashing and remains lit) and to prepare the dishwasher for use (when End appears on the display).</p>
	<p>2) AT THE END OF THE DAY Press the  button until rE appears on the display. Regeneration starts and L3 flashes more quickly. The complete drainage procedure is then carried out (L2 flashes and "UnLoAd" scrolls on the display).</p>
	<p>When pump-out is complete the appliance switches off.</p>

Topping up with regenerating salt



Warning: use specific salt only, do not use cooking sea salt. Salt must be supplied when the led under the symbol indicated in the left side picture lights up. The salt container has a capacity of about **1 kg of granulated salt**. The container is located on the bottom of the tank and it is fitted with two caps.
A: screw cap - **B:** bayonet cap
 After extracting the basket, unscrewing cap **A** and extracting cap **B**, pour the salt using the provided funnel. Remove salt residues near the opening, if present, before placing the caps.

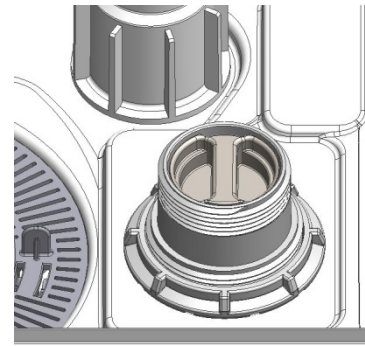
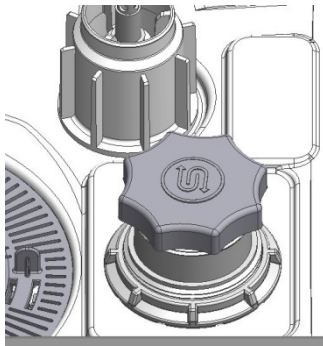

Correct procedure to refill the regenerating salt:

- start a **tank pump-out**,
 - **refill the regenerating salt**,
 - **fill the tank (FILL)**
 - restart the **tank pump-out**
 - remove any salt residues from the bottom of the tank, as it may cause corrosion/rust.
- This procedure **prevents** the washing water to enter the salt container (possible damage to the decalcifier) and that possible residues of salt are left in the tank (risk of corrosion/rust).

12.5 Lengthy periods out of use

If the dishwasher is to be out of use for a fairly long period of time, **the detergent and rinse aid dispenser devices must be emptied to prevent crystallisation and damage to the pumps:** remove the intake hoses from the detergent and rinse aid containers and place them in a container of clean water, then perform a few wash cycles followed by a complete pump-out. Finally, turn off the master switch, close the water intake valve and leave the hood ajar until the interior is completely dry. The detergent and rinse aid intake hoses must be put back into the containers when the dishwasher is returned to service, **taking care not to swap them over** (red hose = detergent, blue hose = rinse aid).

13 TROUBLESHOOTING

PROBLEM	POSSIBLE CAUSE	POSSIBLE SOLUTION
THE INDICATOR LIGHT L1 DOES NOT LIGHT UP	line voltage failure	Verify electricity connection.
THE WASHING PROGRAM DOES NOT START	The dishwasher filling is not over yet.	Wait for FILL to disappear off the display
	CLOSE stays on display	If CLOSE stays even with the hood closed, contact the After-Sales Service.
POOR WASHING RESULTS	Clogged or crusted spray arms holes.	Dismount and clean the spray arms (10.2 Periodical checks)
	Clogged filter	Read "cleaning the filters during the day"
	Insufficient or improper detergent or rinse aid.	Verify detergent type and quantity.
	Failing or insufficient use of detergent or rinse aid: the detergent or rinse aid cannot be withdrawn from the dedicated containers.	Worn or broken internal tube for detergent or rinse aid of the peristaltic pump, to be replaced by the After-Sales Service. This ordinary maintenance service is recommended at least once a year for the correct functioning of the dosers.
	Badly positioned dishes / glasses.	Place dishes / glasses correctly.
	Low washing temperature	Verify the temperature displayed, if it is inferior than 50°C contact customer Support.
	Improper set cycle	Increase the duration of the washing cycle, especially if the load is very dirty or partially dried.
Clogged nozzles Boiler incrustated with limescale	- Verify that the nozzles are clean and that the water softener, if present, is working correctly. - Verify that the filter of the tube placed inside the rinse aid jerrycan is not clogged.	

<p>INSUFFICIENT RINSE</p>	<p>Inappropriate rinse aid, or it is not dispensed correctly. Low rinsing temperature</p>	<p>Verify the rinse aid container and if it is adequate to the type of mains water. Verify the boiler set temperature Restore T Stop ON and/or connect the machine to hot water. If the problem is not solved, contact the After-Sales Service.</p>
<p>INSUFFICIENT DRYING</p>	<p>Inappropriate rinse aid, or it is not dispensed correctly. Water hardness superior than 12°dF or it contains many dissolved salts.</p>	<p>Verify the rinse aid container and if it is adequate to the type of mains water. If the problem is not solved, contact the After-Sales Service</p>
<p>STAINED GLASSES AND CUTLERY</p>	<p>Waste tube badly positioned or partially clogged.</p>	<p>Verify that the tube and drainage are not clogged and that the drainage is not positioned too high; see connection scheme.</p>
<p>WATER LEFT IN THE TANK AFTER PUMP-OUT.</p>	<p>Waste tube badly positioned or partially clogged.</p>	<p>Verify that the tube and drainage are not clogged and that the drainage is not positioned too high; see connection scheme.</p>

14 MALFUNCTIONS SHOWN ON THE DISPLAY (FOR THE USER)

The dishwasher can show a series of malfunctions on display. After the machine has been switched off and restarted, if the problem is not solved, follow the steps below: **(FOR A MORE PROFICIENT AFTER-SALES SERVICE, ALWAYS TAKE NOTE OF THE INDICATED ERROR)**

Err04	Tank temperature probe anomaly	Contact After-sales Service
Err05	Tank water filling anomaly	Check that the water supply tap is open, the dynamic supply pressure, cleanliness of the inlet water filter. If the problem still occurs, contact After-sales Service.
Err06	Water pump-out anomaly (water remains in the dishwasher)	Check that the filters are clean, and that the drain pipe is not bent, obstructed, narrowed. Check that the drain pump is not blocked with a foreign body, follow steps indicated in "10.2 Periodical checks". If the problem still occurs, contact After-sales Service.
Err09	Excessive water level in the tank anomaly	Contact After-sales Service
Err23	Boiler heating anomaly (does not heat)	Contact After-sales Service
Err24	Boiler temperature probe anomaly	Contact After-sales Service
Err25	Boiler water filling anomaly	Check that the water supply tap is open, the dynamic supply pressure, cleanliness of the inlet water filter. If the problem still occurs, contact After-sales Service.
Err26	Boiler emptying anomaly	Check that the nozzles of the rinsing spray arms are not clogged. If the problem still occurs, contact After-sales Service.
Err27	Boiler emptying anomaly – with full tank	Contact After-sales Service

19.390.7209.00	02/02/2018
Rev. Manuale	Data