

**TRANSLATION OF THE ORIGINAL INSTRUCTIONS**

**SUMMARY**

<b>1</b>	<b>PRODUCT IDENTIFICATION</b> .....	<b>3</b>
1.1	APPLICATION, GENERAL FUNCTIONS AND INTENDED USE.....	3
1.2	NAME AND ADDRESS OF MANUFACTURER OR DISTRIBUTOR.....	3
1.3	DECLARATION OF CONFORMITY TO PRODUCT STANDARDS.....	3
1.4	DESCRIPTION OF THE APPLIANCE.....	4
<b>2</b>	<b>SYMBOLS USED IN THE MANUAL</b> .....	<b>5</b>
<b>3</b>	<b>SAFETY PRECAUTIONS AND INSTRUCTIONS</b> .....	<b>6</b>
3.1	CORRECT INSTALLATION.....	6
3.2	SAFE USE.....	7
3.3	CORRECT MAINTENANCE.....	8
<b>4</b>	<b>PRODUCT CHARACTERISTICS</b> .....	<b>9</b>
4.1	OVERALL DIMENSIONS.....	9
4.2	TECHNICAL CHARACTERISTICS.....	10
<b>5</b>	<b>PREPARING THE APPLIANCE FOR USE</b> .....	<b>11</b>
5.1	POSITIONING AND INSTALLATION.....	11
5.2	CONNECTION TO THE WATER SUPPLY.....	12
5.3	DRAIN CONNECTION.....	12
5.4	CONNECTION TO THE ELECTRICITY SUPPLY.....	13
<b>6</b>	<b>FIRST START-UP</b> .....	<b>14</b>
6.1	FIRST START-UP.....	14
6.2	PREPARING FOR USE ( IMPORTANT ).....	14
6.3	USING THE WATER SOFTENER (ON MODELS WITH THIS FEATURE ONLY).....	14
<b>7</b>	<b>CONTROL PANEL</b> .....	<b>15</b>
7.1	SET-UP (AUTHORISED STAFF ONLY).....	16
7.2	MODIFIABLE PARAMETERS.....	17
7.3	STARTING THE PERISTALTIC PUMPS – RAPID FILLING OF DETERGENT AND RINSE AID DELIVERY CIRCUIT.....	20
<b>8</b>	<b>MALFUNCTIONS SHOWN ON THE DISPLAY (FOR THE TECHNICIAN)</b> .....	<b>21</b>
<b>9</b>	<b>INSTRUCTIONS FOR THE USER</b> .....	<b>23</b>
	RED LIGHT: INDICATES A MALFUNCTION.....	23
9.1	BEFORE WASHING.....	24
9.2	FIRST USE EACH DAY (TANK AND BOILER EMPTY).....	25
9.3	OPERATING ANOMALIES.....	26
9.4	PROGRAM CHANGE.....	27
<b>10</b>	<b>CHOSING THE PROGRAM</b> .....	<b>28</b>
<b>11</b>	<b>BASKETS PROVIDED</b> .....	<b>29</b>
<b>12</b>	<b>MAINTENANCE AN CLEANING</b> .....	<b>30</b>
12.1	CLEANING THE FILTER DURING THE DAY.....	30
12.2	TOTAL PUMP-OUT AT THE END OF THE DAY.....	31
12.3	TOPPING UP WITH REGENERATING SALT (FOR MODELS WITH SOFTENER).....	31
12.4	ROUTINE INSPECTION OF THE SPRAY ARM (ONCE A WEEK).....	32
12.5	LENGTHY PERIODS OUT OF USE.....	32
<b>13</b>	<b>TROUBLESHOOTING</b> .....	<b>33</b>
<b>14</b>	<b>MALFUNCTIONS SHOWN ON THE DISPLAY (FOR THE USER)</b> .....	<b>35</b>

**NELSON** thanks you for choosing one of its products.

This manual is an integral part of the appliance. Take good care of it and keep it to hand throughout the appliance's life cycle, since it contains important information about assembly, safety, use and maintenance.

In the event that the appliance is sold on, consign this manual to the new owner. Before putting the appliance into operation, read all the instructions in this manual carefully to become familiar with the right conditions for the proper use of your professional dishwasher.

# 1 PRODUCT IDENTIFICATION

## 1.1 Application, general functions and intended use

This dishwasher is intended for professional use in the restaurant and institutional catering sector and complies with the relevant safety regulations. However, misuse may cause injury and/or damage, and therefore the dishwasher must only be used by suitably trained staff. This dishwasher is designed for use in non-mobile premises and is intended only for washing tableware (dishes, pans, trays, cups, glasses and bowls) and any other item for commercial catering, stable to temperature and humidity produced by the appliance". Any other type of use is not permitted and may be dangerous.

Persons whose physical, sensory or mental capabilities, inexperience or lack of knowledge render them unable to use the dishwasher safely must not use it without the supervision and guidance of a responsible person. The manufacturer is not liable for any injury or damage caused by failure to comply with the instructions given in this manual, misuse, tampering with even a single part of the appliance, or the use of non-genuine spare parts.

## 1.2 Name and address of manufacturer or distributor

Nelson Dish & Glasswashing Machines Unit 1 Rowley Industrial Park Roslin Road Acton  
LONDON W3 8BH 020 8993 6198 Our whole product offering can be viewed at:  
[www.nelsonwash.co.uk](http://www.nelsonwash.co.uk) International customers, please contact your local Nelson distributor.

## 1.3 Declaration of conformity to product standards

This appliance complies with the relevant safety regulations and conforms to the requirements of directives 2006/42/EC and 2004/108/EC.

The dishwasher is also marked in compliance with European Directive 2002/96/EC on Waste Electrical and Electronic Equipment (WEEE).







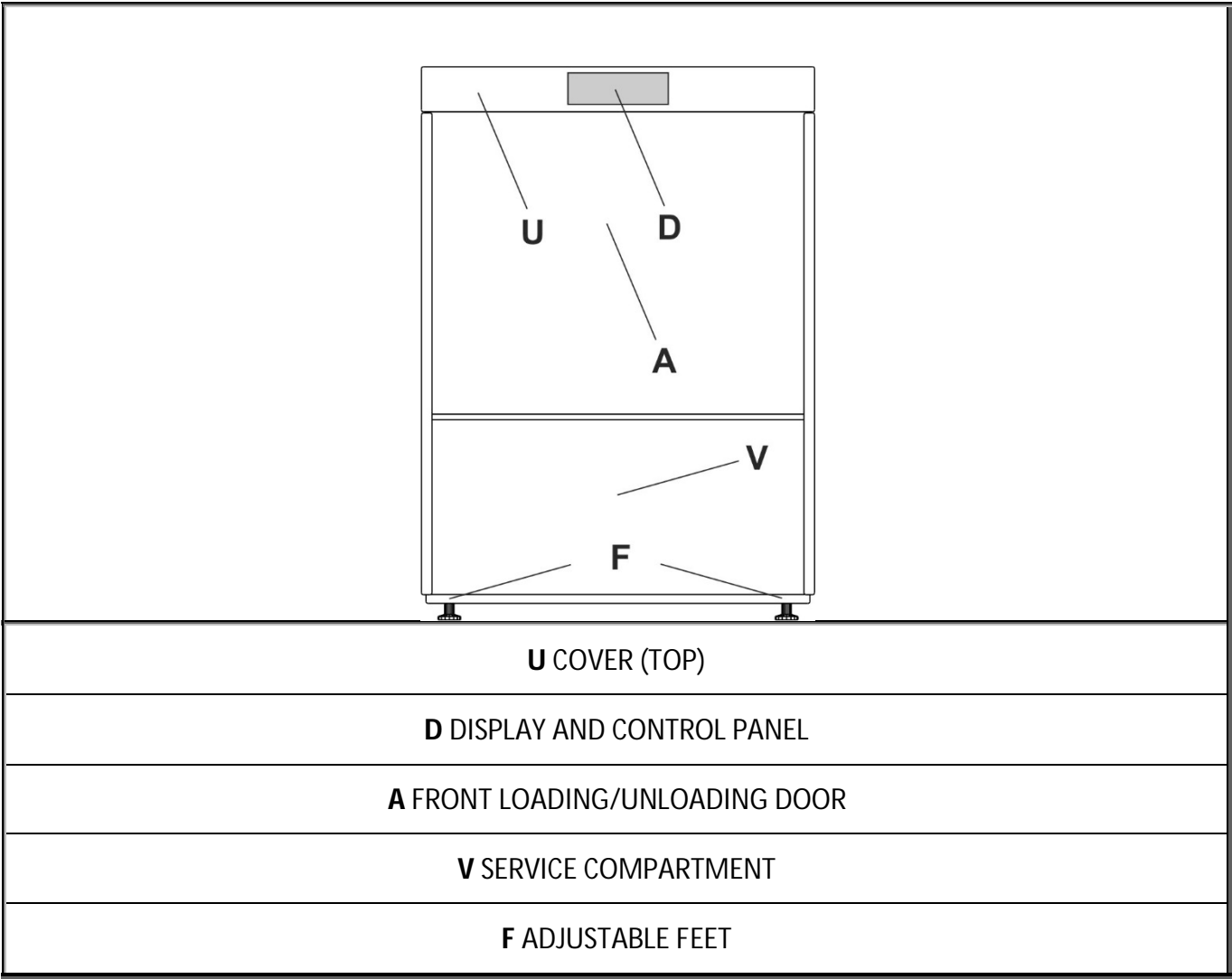

For information on the treatment, recovery and recycling of this product, contact the local authority, domestic waste collection service, or your reseller.

Make sure that this product is scrapped correctly to safeguard the environment and health.

**1.4 Description of the appliance**



## 2 SYMBOLS USED IN THE MANUAL

	This symbol instructs the user to read the instructions in the manual with care.
	This symbol appears next to information important for the safety of people and the appliance.
	This symbol is applied to some parts which contain live electrical components and indicates the risk of electric shock.
	This symbol is applied close to the terminal for the connection of an external equipotential conductor.
	This symbol appears next to important information. Read the instructions provided with care and comply with the procedures and rules described.
	This symbol appears next to information and technical instructions intended for the qualified staff who are to install, commission and test the appliance and carry out any repairs.
	This symbol indicates that at the end of its working life, the appliance must be consigned to a disposal plant for recovery and recycling in accordance with the relevant legislation in the country of installation. Contact a specialist centre for disposal.

### 3 SAFETY PRECAUTIONS AND INSTRUCTIONS

The precautions and instructions below contain important information and must be read with care. The manufacturer does not accept responsibility for damage caused by failure to comply with the safety precautions and instructions.

#### 3.1 Correct installation

- The dishwasher must be installed by an authorised technician.
- When handling and installing the dishwasher, always wear the most suitable personal protection equipment (PPE) for the task in hand.
- Do not install a dishwasher which has been damaged during transport. If in doubt, consult your dealer.
- If the power supply cable is damaged, do not run the dishwasher.
- Do not install the dishwasher in areas subject to freezing temperatures or in atmospheres with explosion risk (ATEX).
- Any accessories may only be installed on the appliance if authorised by the manufacturer.
- Do not install the dishwasher next to appliances which irradiate strong heat (e.g. gas burners, stoves, etc.) since they could cause damage.
- If the dishwasher is installed above the ground, make sure that the stand and dishwasher are secured properly and do not constitute a hazard.
- Electrical safety is only ensured if the dishwasher is connected to an earth conductor compliant with the relevant electrical regulations. If in doubt, have the system inspected by a qualified electrician.
- A circuit breaker and overcurrent protection device (magnetothermal switch or fuses) must be installed in an easily accessible position on the dishwasher's power supply line. This device must only serve the dishwasher and must be suitable for its rated electrical characteristics.
- Do not connect the dishwasher to the electrical mains by means of adapters or extensions, since they do not guarantee the safety required.
- If the dishwasher is connected to the electrical mains by means of a plug, it must be of the same type as the power socket, suitable for the appliance's rated electrical characteristics and compliant with the relevant national regulations on electrical systems. The power plug must be easily accessible after the appliance has been installed.
- Only use new hoses for connection to the water supply. Old hoses or hoses salvaged from previous installations must not be used.
- The drain connection must be made in accordance with the relevant national regulations. Substandard connections may cause flowback and in some cases pollution.
- If the machine is not installed in a recess, ask the manufacturer for the special mounting kit in order to make it stable.

### 3.2 Safe use

- The staff assigned to use the dishwasher must be suitably trained and instructed.
- The appliance is not suitable for use by juveniles or persons with reduced physical, sensorial or mental capacities, or those without the necessary knowledge and experience. Such persons may only use the appliance under the supervision of a person responsible for their safety.
- Do not leave the dishwasher door open. Risk of tripping or injury against the edges of the door.
- Do not sit or lean on the open door. This may tip over or damage the appliance.
- The water inside the dishwasher is not drinkable.
- Do not use the dishwasher for washing or soaking foods.
- Do not use the water inside the dishwasher for defrosting foods, even if they are in airtight containers.
- When using the dishwasher, remember that the plates are very hot at the end of a wash cycle.
- Take care when opening the door as you might be splashed with water.
- When the door is opened, splashed of hot water may come out.
- Knives and pointed kitchen equipment must be placed in the basket with their tips downwards, or horizontally, taking care not to allow them to protrude from the basket
- The dishwasher is only intended for use with water and detergents suitable for washing in professional dishwashers. The use of other products may damage both the dishes and the appliance.
- Do not operate the dishwasher with organic solvents or flammable liquids. Never load dishes dirty with ash, wax or paint.
- When handling detergents comply strictly with the instructions provided by the detergent producer.
- Always keep the detergent safety datasheets within reach so that the operator can consult them easily if necessary.
- Swallowing or inhaling detergents may cause serious injury to the nose, mouth and throat. If detergent has been inhaled or swallowed, seek medical advice immediately.
- When the door is opened, splashed of hot water may come out.
- It is recommended to use baskets that are intact and not damaged by wear or tampering. The plastic runners of the baskets, if present, must not be removed, damaged, modified or tampered with.

### 3.3 Correct maintenance

- Do not clean the machine with a water jet machine, high-pressure or steam cleaners.
- Before performing any maintenance procedure on the appliance disconnect it from the mains electricity supply. Touching live electrical components, even accidentally, may be very dangerous.
- Never open the dishwasher's case. Electric shock hazard. Only the authorised technician may access the internal parts of the dishwasher.
- The dishwasher may only be repaired by the authorised service organisation. Substandard repairs may cause damage or danger for the user.
- No alterations or changes of any kind to the appliance's electrical circuits or mechanical structure are permitted. The manufacturer declines all responsibility for damage arising from unauthorised alterations.
- Replace any faulty parts only with genuine spare parts. The manufacturer declines all liability for damage resulting from the use of non-genuine spare parts.
- The power supply cable, if fitted, must be replaced by the manufacturer or an authorised service centre in accordance with the technical data specified on the wiring diagram supplied with the appliance, to prevent all risks.

## 4 PRODUCT CHARACTERISTICS

### 4.1 Overall dimensions

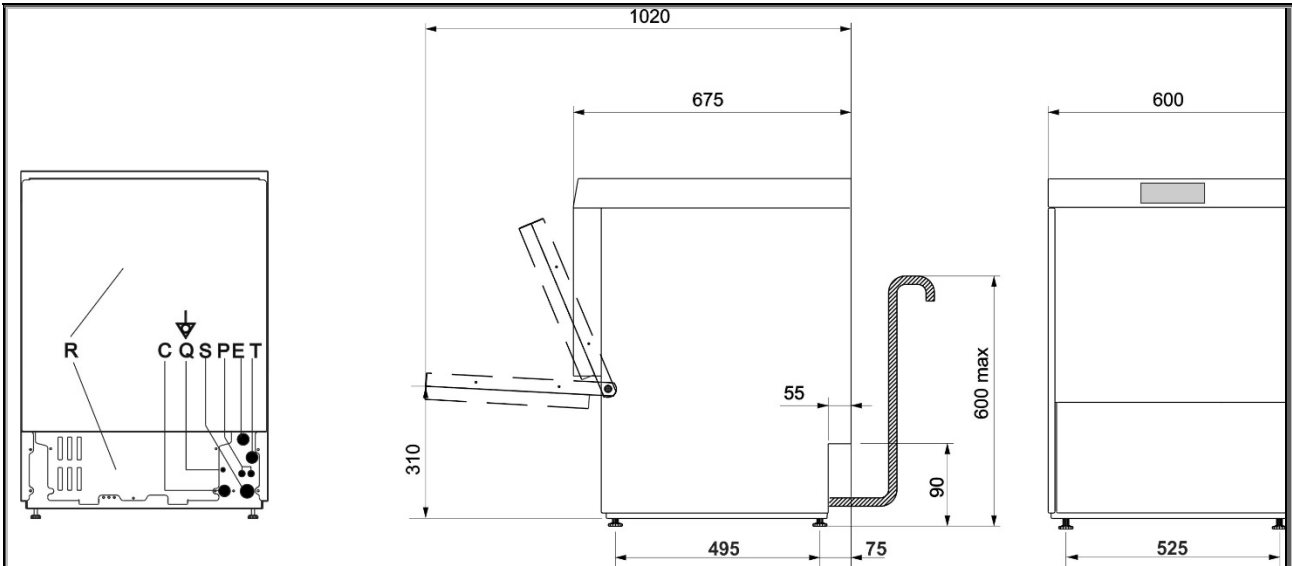

R	LOWER BACK PANEL	E	ELECTRICITY SUPPLY CABLE
C	FILLER HOSE	P	PERISTALTIC HOSES
Q ↓	EARTH TERMINAL	S	DRAIN HOSE
T	EXTERNAL DISPENSER POWER CABLE ENTRY POINT		

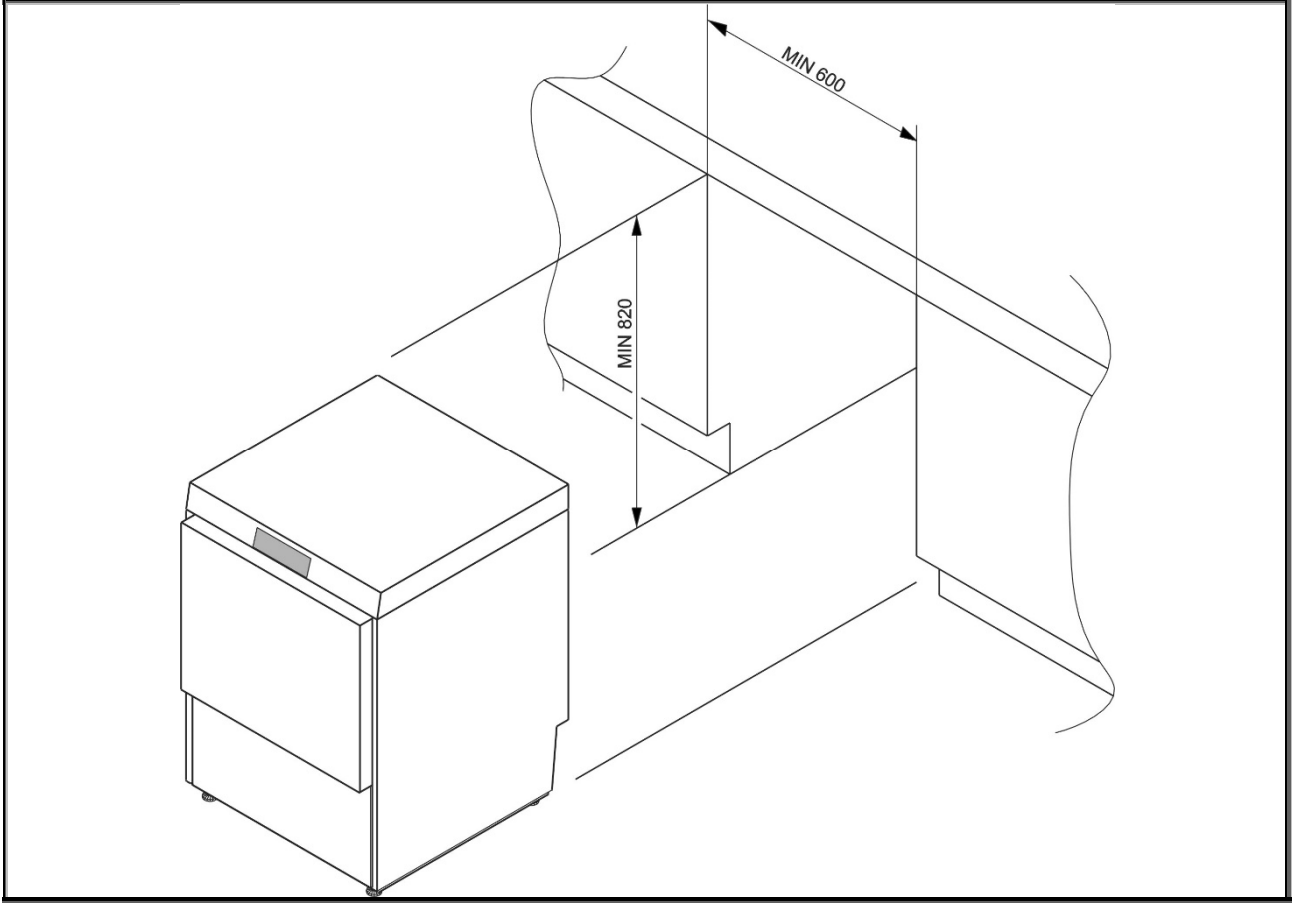

## 4.2 Technical characteristics

Electricity supply	-	See technical data plate and electrical wiring diagram supplied with the appliance
Intake water pressure	-	
Intake water temperature	-	
Use	-	Indoor
Max. working altitude	m	2000
Working ambient temperature	°C	10 - 35
Relative humidity		80% for temperatures up to 25°C with linear decrease to 50% at the temperature of 35°C
Intake water hardness (models with softener)	°f/°d/ppm	≤ 60/≤ 34/≤ 600
Intake water hardness (models without softener)	°f/°d/ppm	≤ 3/≤ 5/≤ 30
Water intake flow rate (models with rinsing pump)	L/min	min 6
Water intake flow rate (models without rinsing pump)	L/min	min 12
Intake hose connection	-	threaded 3/4 "
Drain minimum diameter	mm	25
Drain height (above appliance installation surface)	mm	max 600
Rinse cycle water consumption	L	3.2
Boiler capacity	L	6
Tank capacity	L	11
Noise level	LpA	< 60 dB(A)
Degree of protection	IPX	4
Net weight	kg	~ 55
Power supply cable type	◀HAR▶	H07RN-F

## 5 PREPARING THE APPLIANCE FOR USE

Convey the dishwasher to the installation site, remove the packaging and check the appliance and components for damage; any damage found must be reported to the transporter in writing. The packaging components (plastic bags, expanded polystyrene, nails, etc.) must not be left within reach of children and pets since they are potentially dangerous. All packaging materials used are environment-friendly. They can be kept without constituting any hazard, or may be disposed of at a specialist waste disposal centre. The plastic components suitable for recycling are marked as follows:

PE - polyethylene: external packaging film, bag containing the instructions, protective bags.

PP - polypropylene: straps used to close the packaging.

PS - expanded polystyrene: corner guards, top of packaging.

Wooden and cardboard components can be disposed of in accordance with the local regulations.



All operations described in this section must be carried out and/or checked by the qualified staff who install and commission the dishwasher.

### 5.1 Positioning and installation

Place the dishwasher in the chosen point and remove the protective film. Level the dishwasher (with the aid of a spirit level) on its four feet, adjusting them to ensure that it is stable. If the dishwasher is installed above the ground, make sure that the stand and dishwasher are secured properly and do not constitute a hazard.



The systems and premises in which the dishwasher is installed must comply with the relevant regulations.



If the dishwasher is installed next to another appliance, also check the recommendations provided by the manufacturer of the adjacent appliance.



Installations other than those described must first be approved by the manufacturer.



Use only professional furnishings and units in the vicinity of the dishwasher. Any other types of furnishing may be damaged.

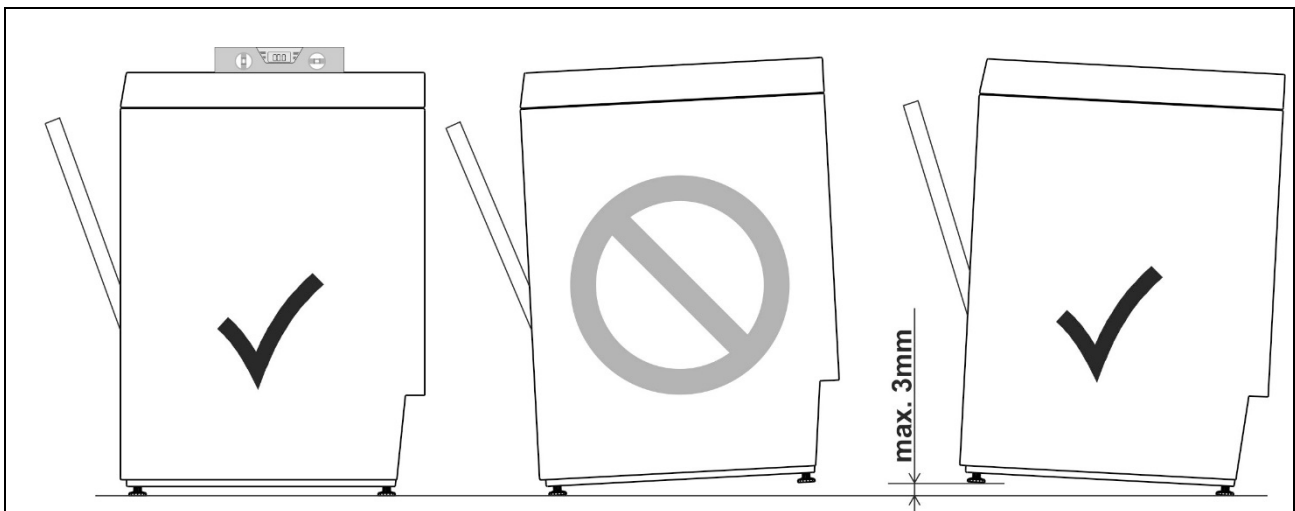

## 5.2 Connection to the water supply

Check that the intake water pressure, flow rate and temperature are as stated in the dishwasher's technical characteristics. If the dynamic pressure exceeds the limit stated in the technical characteristics, a pressure reducer must be installed. If the pressure is lower, it might be necessary to fit a special pump to ensure optimal performance. Connect the water intake hose to a connector with  $\frac{3}{4}$ " gas threaded fitting, inserting the filter "A" provided. The tap must be easily accessible after installation of the appliance.

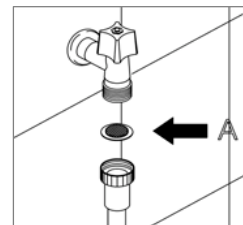

Only use new hoses for connection to the water supply. Old hoses or hoses salvaged from previous installations must not be used.



If the water supply system has been unused for a long time or if work has been done on it, before connecting the appliance's intake hose run the water to flush the air and dirt from the pipes.



### FOR MODELS WITH A WATER SOFTENER

An "approved" double check valve or some other no less effective device providing backflow prevention protection to at least fluid category two shall be fitted at the point of connection between the water supply and the fitting or appliance.

### FOR MODELS WITHOUT A WATER SOFTENER

An "approved" single check valve or some other no less effective device providing backflow prevention protection to at least fluid category two shall be fitted at the point of connection between the water supply and the fitting or appliance.

## 5.3 Drain connection

The dishwasher is fitted with a drain pump and can operate with drain connections on the floor or wall. Before connecting the hose, check that the diameter and height of the wall drain connection are as stated in the dishwasher's technical characteristics. When connecting the dishwasher's drain hose, take care to avoid kinks, sharp bends or crushing. Since the drain water temperature can be very high, the end of the drain hose must be fixed to the drain connection using the hose clamps provided.



The drain connection must be made in accordance with the relevant national regulations. Substandard connections may cause flowback and in some cases pollution.



No extensions must be added to the drain hose supplied with the appliance. Any extensions might cause drainage problems.

## 5.4 Connection to the electricity supply

The dishwasher must be connected to the electrical system by authorised, skilled staff, in accordance with the relevant regulations. Also comply with the technical instructions for the connection provided with the appliance. The dishwasher's rated electrical characteristics are provided on its technical data plate. A circuit breaker with contact gap rated for category II overvoltage and an overcurrent protection device (magnetothermal switch or fuses) must be installed in an easily accessible position on the dishwasher's power supply line. These devices must only serve the dishwasher and must be suitable for its rated electrical characteristics. The electrical protection devices must undergo a functional test before the dishwasher is put into operation. If the dishwasher is connected to the electrical mains by means of a plug, it must be of the same type as the power socket, suitable for the appliance's rated electrical characteristics and compliant with the relevant national regulations. The power plug must be easily accessible after the appliance has been installed.



Electrical safety is only ensured if the dishwasher is connected to an earth conductor compliant with the relevant electrical regulations. If in doubt, have the system inspected by a qualified electrician.



Do not connect the dishwasher to the electrical mains by means of adapters or extensions, since they may cause dangerous overheating.



**Connect the appliance to the equipotential bonding system. The equipotential terminal is low down on the back of the appliance and is marked with the  $\nabla$  symbol.**



Additional recommendation: class B all-current sensitive residual-current circuit breaker with a tripping current of 30 mA.



The dishwasher is always powered up unless the master switch is turned off or, on appliances with power plug, the plug is disconnected.

## 6 FIRST START-UP

### 6.1 First start-up

The electrical protection system must undergo a functional test before the appliance is put into operation.

The appliance must be installed and/or inspected by qualified staff, who will start it up for the first time and provide the relevant operating instructions.

### 6.2 Preparing for use ( Important )

The rinse aid dispenser is fitted on all models, the detergent dispenser only on some.

**If both dispensers** are present put the external detergent and rinse aid containers in place and insert the respective intake hoses on the rear of the appliance into them. Red hose: detergent, blue hose: rinse aid.

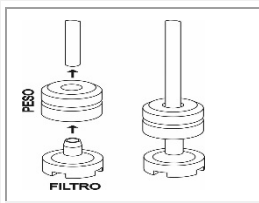

Before inserting the hoses into the containers, fit the weights (needed to ensure that they always draw in liquid from the bottoms of the containers) and the filters onto their ends as shown. If the detergent dispenser is not factory-fitted, it can be retrofitted after ordering the relative kit.

### ! IMPORTANT: !

Whenever the type of detergent or rinse aid is changed, it is **ABSOLUTELY ESSENTIAL** to flush out the peristaltic pumps by placing the external intake pipes in water for a few cycles. Always use only products specifically recommended for use in a professional dishwasher. Failure to comply with this recommendation leads to **forfeiture of the warranty** entitlement on the appliance's water system. Replacement of the **internal tube** of the detergent and rinse aid peristaltic pumps is **recommended every 12 months or 15.000 wash cycles**, by the After-Sales Service.

### 6.3 Using the water softener (on models with this feature only)



The quantity of lime in the water (which indicates its hardness) causes whitish marks on dry dishes and dishes also tend to lose their shine over time. The dishwasher is equipped with an automatic water softener which removes the substances that cause hardness from the water with the aid of regenerating salt.



The first time the dishwasher is used, a litre of water must be poured into the tank with the salt. Whenever the tank is filled, always take care to ensure that the cap is firmly closed. The mixture of water and detergent must not get into the salt tank, as this would impair operation of the regeneration system. In this case warranty cover will be forfeited.

## 7 CONTROL PANEL

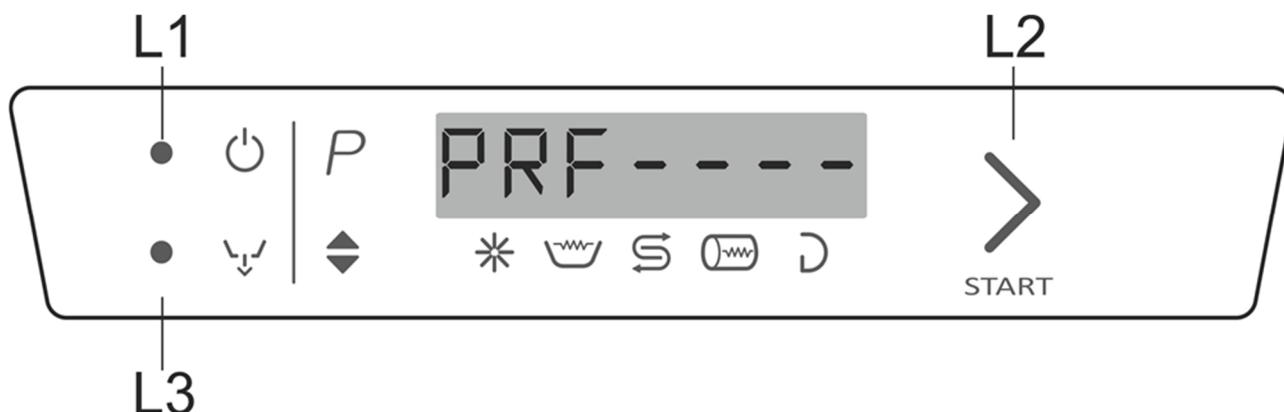

	On-off button
	Program selection button
	Start CONFIRM/PAUSE button
	Total emptying button (tank and boiler)
	Additional function selection button
	<b>L1</b> Mains power on light
	<b>L2</b> Light indicating dishwasher in operation, cycle running, FILL running.... (blue), ready (green), malfunction (red)
	<b>L3</b> Pump-out in progress light
	No rinse-aid symbol (if a system for monitoring outside the dishwasher is provided)
	Tank heating element on symbol
	No salt symbol (if softener is fitted)
	Boiler element on symbol
	No detergent symbol (if a system for monitoring outside the dishwasher is provided)

Light L2

**Green light: dishwasher ready**

**Blue light: dishwasher in operation (washing in progress, FILL in progress ...)**

**Red light: indicates a malfunction**

The instructions apply to "undercounter" and hood-type dishwashers, so some sections of the manual may describe procedures referring to one or the other type, depending on the model purchased (e.g. open the door/lift the hood...).



	<p>When the display control panel is switched on, the display shows the type of dishwasher (PRF 400, PRF 500, CAPOTE.....), followed by the firmware version and update installed.</p>
	<p>If the dishwasher is already powered up, press the on/off button for direct display of the firmware version and update installed.</p>



### 7.1 SET-UP (Authorised staff only)



**Set-up**  
During first start-up, the functions/parameters listed below must be set or adjusted:

#### Dishwasher parameter modification procedure



<p><b>With the tank empty</b></p> <p>1- Switch the appliance on; the display will show "FILL" and filling will start.</p> <p>2- Open the door/lift the hood (depending on the model); "CLOSE" will appear on the display</p> <p>3- Press the  button and hold it down for 5/7 seconds. When ----- appears on the display, release the button and press it again to access the main PCB setup menu.</p>	
<p><b>With the tank full/the hood open</b></p> <p>1 - Press the  button and hold it down for 5/7 seconds. When ----- appears on the display, release the  button and press it again to access the main PCB setup menu.</p>	

All the modifiable parameters can now be displayed, scrolling through them with the  button. Press the  button to select the value required for each parameter. To confirm the value required simply quit the menu or move on to the next parameter by pressing .

**Quitting the setup menu automatically:** wait **about 3 minutes** without using the controls.  
**Quitting the setup menu in manual mode:** hold the **ON/OFF** button until the **beep** sounds; the dishwasher switches off.

## 7.2 Modifiable parameters

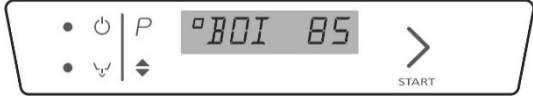
The illustrations are purely guideline. The minimum and maximum temperatures available depend on the model (glass washer, dishwasher, undercounter or hood-type model, ..).

<p><b>Rinsing temperature (boiler temperature)</b></p> 	<p><b>Washing temperature (tank temperature)</b></p> 
<p><b>Warning:</b> The tank and boiler temperatures shown on the display may be different from the actual temperatures by a few degrees, especially in transient phases (just after the FILL is completed, just after the end of the cycle, etc.) due to the inertia of the measurement probe.</p>	

### Adjusting rinse aid dispensing (optional if installed)

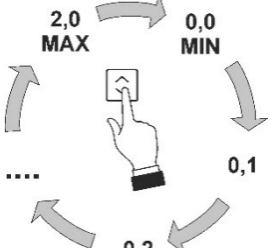
		<p>Every time  is pressed, the value increases of 0,1 g/l up to a max. of 2 g/l.</p> <p><b>Default: 1,2 g/l.</b></p>
---	---	--

**NOTE:** Do not exceed the amount indicated by the manufacturer, as shown on the package. An excessive amount may cause foaming.

### Adjusting detergent dispensing (optional if installed)

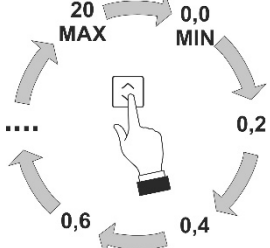
		<p>Every time  is pressed, the value increases of 0,2 g/l up to a max. of 20 g/l.</p> <p><b>Default: 2,6 g/l.</b></p>
---	--	---

**NOTE:** Do not exceed the amount indicated by the manufacturer, as shown on the package. An excessive amount may cause foaming.

### Autostart function

	<p>Set at "on" to start the cycle when the hood/door is closed.</p> <p>Set at "off" to start the cycle after confirmation with the start button .</p>
---	---

### Regeneration frequency setup (models with softener)

\* (Default value: **H03**; modify the parameter to suit the mains water hardness.

At first use, the salt tank has to be filled. It is subsequently sufficient simply to fill up with regenerating salt when necessary.

#### Mains water hardness setting table

	Ppm-mg/l	Hardness °d German degrees	Hardness °f French degrees	Setting level
	Regeneration off			
	150	8,5	15	H01
	200	11	20	H02
	300	17	30	* H03
With values over 60°F an external water treatment device must be used and the regeneration frequency <b>must be set on H00</b> .	400	22,5	40	H04
	500	28	50	H05
	600	33,5	60	H06

**Important:**  
During normal operation, the dishwasher will perform a number of washing cycles while regeneration is in progress. During this time (5-6 cycles) the intake water will not be treated, but this will not affect the washing quality.

#### Extra rinse

	<p>Rinsing is <b>10"</b> longer than the standard in each washing cycle.</p> <p><b>On: enabled – OFF: disabled.</b></p>
---	---

#### "Clean water" cycle

	<p>When this option is activated, the appliance pumps out all the water from the tank and then refills it with clean water at every wash cycle. How long this operation takes depends on the washing water temperature.</p> <p><b>On: enabled – OFF: disabled.</b></p> <p><b>N.B.:</b> prolonged use of this option leads to higher detergent and rinse aid consumption.</p>
---	--

### Thermostop



**Set as "on" = minimum rinsing temperature as set**, (see boiler temperature above) regardless of intake water temperature; the cycle duration may be a few seconds longer than the nominal length.

**Set as "off" = the minimum rinsing temperature** might be a few degrees lower than the setting if hot intake water is not used.



If the thermostop device is set "off" the rinsing °t are no longer monitored and the user is responsible for ensuring that the minimum correct °t are maintained for the tank and boiler. It is particularly important to check the intake water temperature.

Also refer to the insufficient washing/drying /foam in tank point of the "troubleshooting" section : restore °t Stop ON and/or connect the appliance to a hot water supply.

### High speed (FST) or economy (ECO) filling (FILL)



**Fast start (FST):** starts the dishwasher in less than the standard time; leads to higher water consumption for the first cycle start.

**Eco start (ECO):** starts the dishwasher in standard time, with no added water consumption.

**On: enabled – OFF: disabled.**

### Cycles performed counter



Shows the count of the total cycles performed by the dishwasher since installation.

**This parameter cannot be modified or reset** unless the software is reprogrammed.

### USER program duration customisation (optional, only if installed)





**USER.** is the only program which can be customised. Scroll through the setup parameters to display **USER.P1, P2.....** followed by two dashes (e.g. **P2--**). Keep pressing the P button until **USER** appears followed by the duration (e.g. **USER. 03.10**).

**Service setting (for After-Sales Service only)**

	<p>Accessing the technical set-up menu. Refer to the specific technical documentation.</p>
---	--

**7.3 Starting the peristaltic pumps – rapid filling of detergent and rinse aid delivery circuit.**

**Perform after the parameter modification procedure explained in the previous point**

<p>With the dishwasher powered up and the tank full, press the on/off  button for a few seconds; when -- -- appears on the display, release the button and press it again <b>quickly within 0.5 seconds</b>. The peristaltic pumps continue to operate until the same button is pressed again. <b>The rinse aid and detergent symbol lights flash alternately as long as the pumps are on</b>; bear in mind that the rinse aid peristaltic pump fills the circuit in about 7 minutes, while for the detergent it only takes 2 minutes. So draw only rinse aid from the jerry cans (1 for the rinse aid and the other for the detergent) for the first 5 minutes and then also take in detergent for the last 2.</p>	
--	---

	<p>On some models, the message “door” (PCB self-diagnostics on dishwasher closure) may appear during the setup procedure. To reset the message, open the dishwasher door and close it again. If the message persists, contact the after-sales service.</p>
---	--

## 8 MALFUNCTIONS SHOWN ON THE DISPLAY (FOR THE TECHNICIAN)

The dishwasher is able to identify a number of malfunctions and show them on the display. If the problem persists after the dishwasher has been switched off and back on, proceed as described below:

<b>Er 04</b>	Tank temperature probe malfunction	Tank temperature probe disconnected or not working.
<b>Er 05</b>	Tank water filling malfunction	<ul style="list-style-type: none"> <li>- The tank wasn't filled in the expected time: check the water supply tap, the dynamic supply pressure, cleanliness of the inlet water filter, cleanliness of the rinse nozzles, any damage of the water charging hose. If the problem still occurs during the "FILL":</li> <li>- Work level tank pressure switch damaged (it always detects "empty": check if the tank safety pressure switch starts operating).</li> <li>- Leakage from the tube connected to the air trap; if the problem is not solved, it occurs during the work program.</li> <li>- vent valve of the drain pipe obstructed with dirt: with siphonage, the tank gets completely empty at the end of a washing program.</li> </ul>
<b>Er 06</b>	Water pump-out malfunction	<p>Check:</p> <ul style="list-style-type: none"> <li>- filter cleanliness; obstructions, bending and narrowing of the drain pipe.</li> <li>- possible obstructions of the drain pump (blocked with a foreign body).</li> </ul> <p>In case the problem is not solved, please contact the After-Sales Service.</p>
<b>Er 23</b>	Boiler does not heat up as expected.	<p>The problem might occur because water is continually entering the tank (the causes are as for "Er 05" – see above) If the boiler heating element is damaged, this might be due to operation with no water in the boiler - the pressure switch is indicating full even with the boiler empty: - damaged boiler heating element – contactor failure - open on boiler safety thermostat side. - boiler temperature probe faulty or incorrectly positioned - motherboard relay failure, Important: If the boiler heating element is damaged, this might be due to operation with no water in the boiler, pressure switch continues to give full reading even with boiler empty: check boiler air trap and/or relative pressure switch and replace if necessary.</p>

<p><b>Er 24</b></p>	<p>Boiler temperature probe malfunction</p>	<p>Boiler temperature probe disconnected or not working</p>
<p><b>Er 25</b></p>	<p>Boiler water filling malfunction</p>	<p>The boiler wasn't filled in the expected time: check the water supply tap, the dynamic supply pressure, cleanliness of the inlet water filter, any damage of the water charging hose, or check the following in this order:          - faulty boiler pressure switch (it always detects "empty"),          - leakage or unbinding of the tube (water runs inside the tube)          - menu service wrong setting "<b>rP</b>"</p>
<p><b>Er 26</b></p>	<p>Boiler emptying malfunction</p>	<p>- check cleanliness of the rinse nozzles          - faulty boiler pressure switch (it always detects "full")          - leakage or unbinding of the tube (water runs inside the tube)          - rinsing pump malfunction (if present)</p>
<p><b>Er 27</b></p>	<p>Boiler emptying malfunction – with tank full          Or boiler full signal on models without rinsing pump</p>	<p>Faulty boiler pressure switch (it always detects "full"). If this occurs in models without rinsing pump, the boiler pressure switch is wrongly detected: check settings in the service menu on entry "<b>rP</b>"  <b>"rp"</b> = on for models with rinsing pump  <b>"rp"</b> = of for models without rinsing pump</p>

## 9 INSTRUCTIONS FOR THE USER

### Control panel

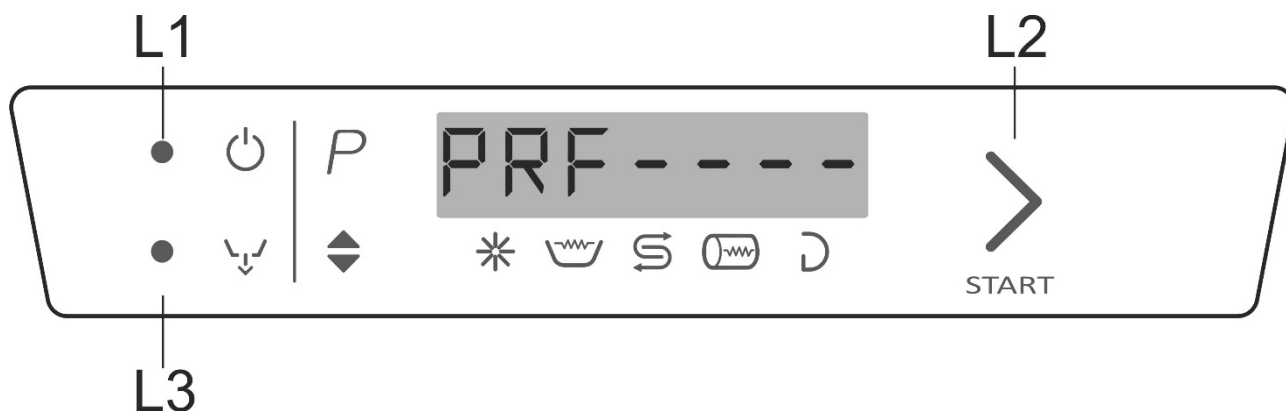

	On-off button
	Program selection button
	Start CONFIRM/PAUSE button
	Total emptying button (tank and boiler)
	Additional function selection button
	<b>L1</b> Mains power on light
	<b>L2</b> Light indicating dishwasher in operation, cycle running, FILL running.... (blue), ready (green), malfunction (red)
	<b>L3</b> Pump-out in progress light
	No rinse-aid symbol (if a system for monitoring outside the dishwasher is provided)
	Tank heating element on symbol
	No salt symbol (if softener is fitted)
	Boiler element on symbol
	No detergent symbol (if a system for monitoring outside the dishwasher is provided)

### Light L2

**Green light: dishwasher ready**

**Blue light: dishwasher in operation (washing in progress, FILL in progress ....)**

**Red light: indicates a malfunction**

The instructions apply to "undercounter" and hood-type dishwashers, so some sections of the manual may describe procedures referring to one or the other type, depending on the model purchased (e.g. open the door/lift the hood...).

### 9.1 Before washing

	Use only detergents and rinse aids for industrial dishwashers. Do not use detergents intended for hand washing. We recommend the use special products, developed for this dishwasher.
	When topping up the tanks, take care not to swap the products; this might damage the dishwasher and cause malfunctions.











Do not mix different detergents; this would damage the dispenser device. **Failure to comply** with this recommendation leads to **forfeiture of the warranty** entitlement on the appliance's water system.

Industrial dishwasher detergents may cause serious irritation. Comply carefully with the instructions provided by the detergent producer on the pack.

**Check:**

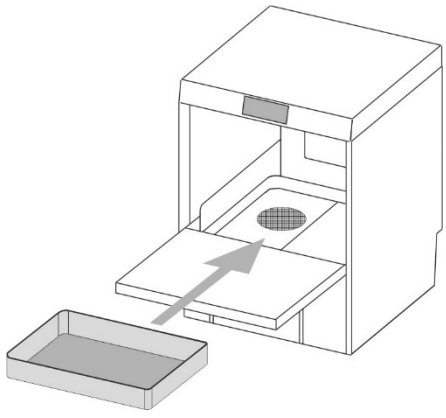
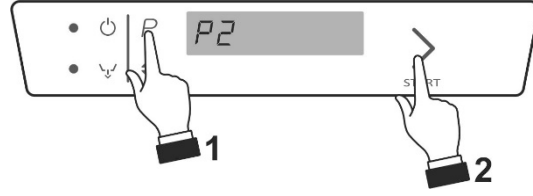
Turn on the mains water tap (user)	The level of detergent and rinse aid in the containers.	That there is regenerating salt in the relative container (if fitted).	That the filters are in place, the spray arms rotate, and there are no foreign bodies in the dishwasher.	Switch on the master switch (user): the decimal points of both digits appear on the display.
		 SALE SALT SEL SALZ SAL		

9.2 First use each day (tank and boiler empty)

	<p><b>With the door/hood closed:</b></p> <p>Press  and hold it down.          The display shows the firmware version and update installed, then the tank and boiler temperatures. This is followed by <b>FILL</b> and the boiler water temperature. The boiler heating element symbol  remains lit until heating finishes. Once the water in the boiler has been heated, filling of the tank starts.</p>
	<p>Wait for <b>P1 - END</b> to appear and light <b>L2</b> to change from blue to green; if the water in the tank has to be heated,  comes on until the set temperature is reached. The duration of this stage may vary depending on the mains water temperature and on the single-phase connection (if possible, depending on the model).</p> <p>Press the  button quickly to display the tank (left) and boiler (right) temperatures for a short time.</p>
	<p>Load the dishes          Close the door and the cycle starts</p>
	<p>1- Select the program required by pressing <b>P</b>.</p> <p><b>Only with Autostart OFF:</b></p> <p>2- Confirm the program start by pressing  and holding it down for 1 second (light <b>L2</b> changes from green to blue).</p>
	<p>Cycle in progress, the progress of the cycle is displayed by vertical bars which illuminate in sequence.</p>
	<p>At the end of the program "<b>END</b>" flashes</p>

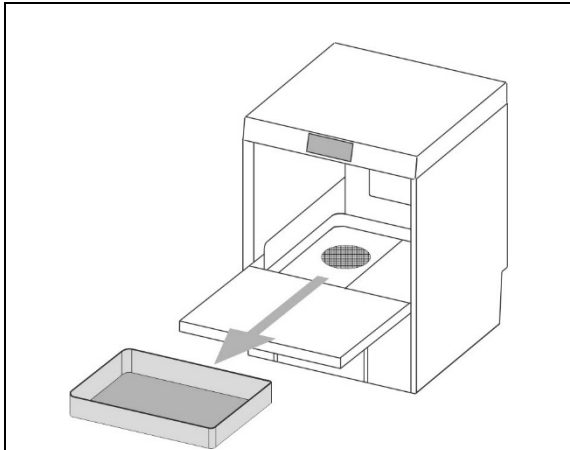

Unload the dishes.  
When the dishwasher is closed again, the system offers the last program run.

9.3 Operating anomalies

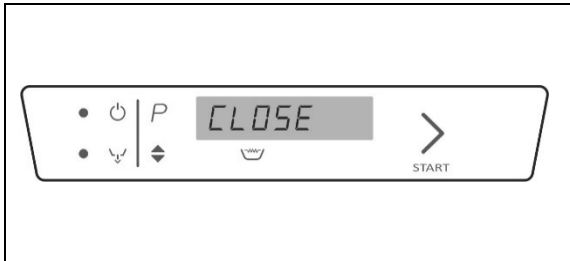



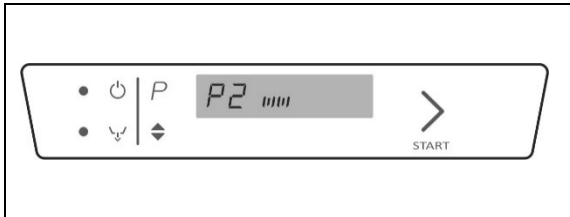

**Open door.**  
If the door is opened with the cycle in progress, **"CLOSE"** flashes and the **program stops**. After closing the door, the program start **must** be confirmed by pressing and holding it down for 1 second (light **L2** changes from green to blue).



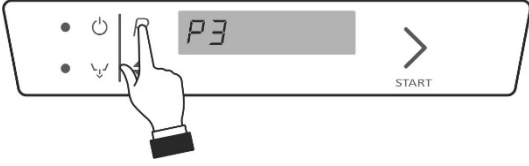
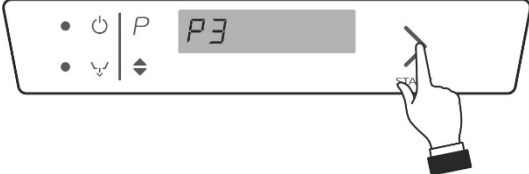

**Power blackout.**  
In the event of a power blackout while the cycle is running, the program stops **and restarts automatically from the beginning** when the power is restored.

### 9.4 Program change

	<p>With program started, press  and hold it down to interrupt it.</p>
	<p>Change the program by pressing</p>
	<p>Confirm the program start by  pressing and hold it down for <b>1 second</b> (light L2 turns blue again).</p>

**N.B.:**

During heating of the water in the boiler and tank with the cycle running, the tank heating element  and boiler heating element  symbols may appear on the display.

**Tank heating does not start until heating of the boiler is completed.**

**Filter presence sensor (on some models only)**

The filter is fitted with a sensor which checks that it is properly fitted; if it is not in the correct position, the word **"FILTER"** appears on the display.

## 10 CHOSING THE PROGRAM

When you scroll through the available programs, the program number (P1, P2, .... etc.) and its duration are shown first, alternating with the wash and rinse temperatures.

PROGRAM		TYPE OF DIRT	DURATION (*)
DISHES S (short)	P1	Lightly soiled plates	1 min
DISHES M (medium)	P2	Medium soiled plates	1 min 30s
DISHES L (long)	P3	Heavily soiled plates	2 min 30s
USER PR. (custom)	P4	Customisable (see "set-up information")	1- 10 min
CUTLERY	P5	Intensive programm with 70°C washing	4 min 10s
GLASS S (short)	P6	Little dirty glasses	1 min
GLASS L (long)	P7	Heavily soiled glasses	1 min 20s

(\*) The cycle duration stated above is guaranteed if the water intake temperature is as stated and recommended in the "TECHNICAL DATA" table, and in all cases refers to the first cycle performed. For repeated cycles, operating conditions may vary from installation to installation. If the dishwasher is supplied with cold water, the cycle duration might increase depending on the intake water temperature and the "thermostop" setting.



### Power blackouts.

If the dishwasher is open when power is restored, the display will read "°t" and the heating element will remain off, to prevent the risk of burns to the user.

**Close the dishwasher to resume heating the water in the tank.**

## ENABLING/DISABLING THE PROGRAM NAME ON THE DISPLAY

By default, the display shows the program number P1, P2, P3, and its duration, alternating with the wash and rinse temperatures. It is also possible to **display** the name of the program. In this case, the name of the program will be displayed first and the progressive program number and the duration will be displayed on the following screen e.g. **Glass >>> P1 1:10**.

The procedure must be carried out with the machine **switched off but powered**.

Press and hold down the **start / pause** button.

When the horizontal lines - - - - appear on the display, **release** the start / pause button and then **press it again immediately**.

The procedure is complete; there is no audible or visual confirmation.

It is possible to check if the procedure has been carried out correctly when the machine is switched on again.

## 11 BASKETS PROVIDED

The shape and material of the baskets provided with the dishwasher depend on the purchased model. Extra baskets can be purchased through the After-Sale Service. The following images are indicative.

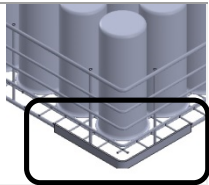
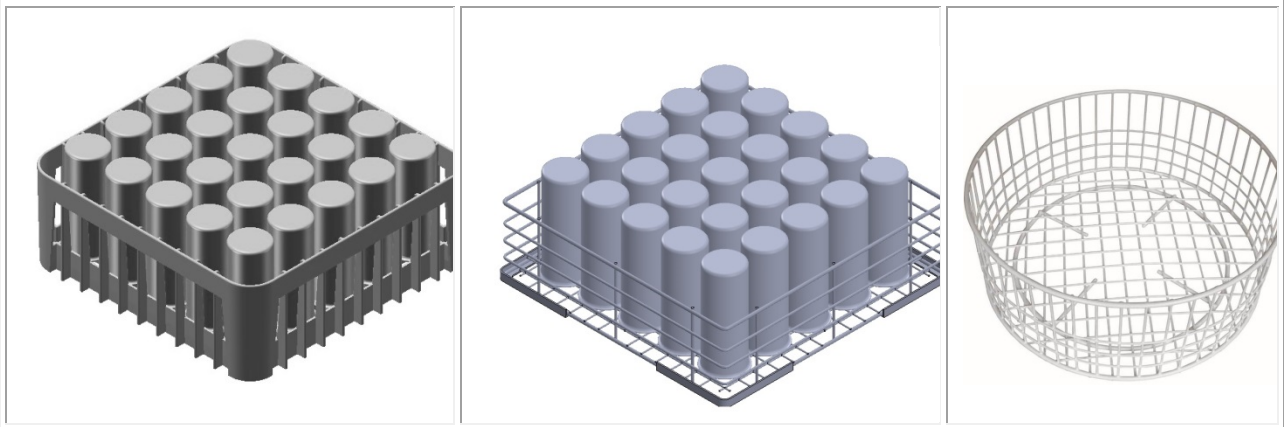

**NOTE:**

It is recommended to use baskets that are intact and not damaged by wear or tampering. The plastic runners of the baskets, if present, must not be removed, damaged, modified or tampered with.

**Glasses:** Place the glasses downwards.

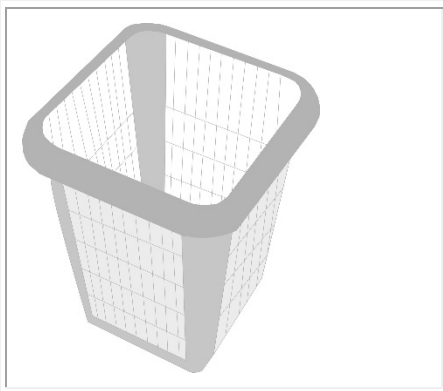

**Cutlery**

Use the dedicated basket. Place the cutlery randomly, preferably with the handle downwards, using caution to avoid injuries due to prongs of forks and blades of knives.

## 12 MAINTENANCE AN CLEANING

We recommend regular servicing by an authorised service centre at least once a year, to guarantee optimal performance at all times.

Consumables (e.g. peristaltic pump hoses) and/or parts subject to wear and tear must be replaced with genuine spare parts. **N.B.:** the manufacturer accepts no liability for wilful damage or damage deriving from carelessness, neglect, failure to comply with instructions, regulations and standards or incorrect connections, which lead to forfeiture of warranty cover.

	The dishwasher has <b>IPX4</b> protection, but the use of direct water jets for cleaning is <b>forbidden</b> .
---	--



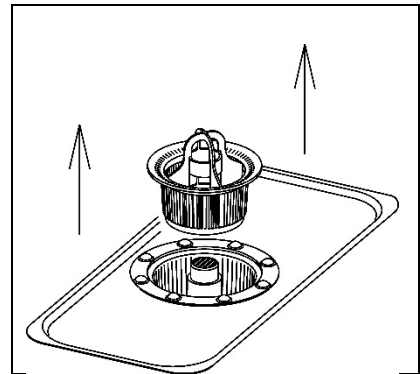

Remove the filters (simply lift them out as shown here), taking care that no large residues fall into the sump underneath. Clean them to remove residues and rinse with plenty of water, then put them correctly back in place; do not use sharp or pointed tools. Clean away any limescale deposits to prevent excessive build-ups; If possible, leave the hood or door ajar when not in use; Clean surfaces thoroughly and often with a damp cloth; use neutral, non-abrasive detergents which do not use chlorine compounds, which corrode and damage stainless steel.



Do not use the products mentioned above even when cleaning the floor underneath or in the vicinity of the dishwasher, to ensure that fumes or drops cannot damage the steel surfaces.

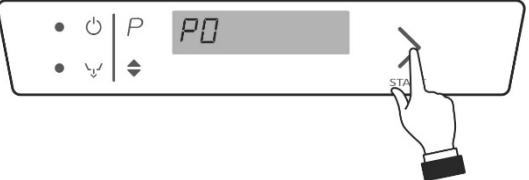

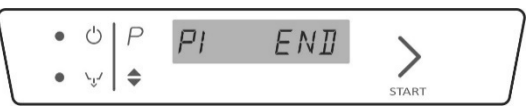

### 12.1 Cleaning the filter during the day

In case of particularly heavy-duty working conditions, the filter should be cleaned every 30-40 cycles, keeping the machine in operating conditions; to do this, carry out the "partial tank pump-out" routine (program "P0") (**TANK UNL**).

	Press the <b>P</b> button, and hold it down, until " <b>TANK UNL</b> " and the duration of <b>2'</b> appear on the display.
	Confirm by pressing  ; light <b>L2</b> turns blue.
	At the end of the pump-out the word " <b>END</b> " flashes on the display. The display returns to showing " <b>P1</b> ". Clean the filter in accordance with the instructions.
<p><b>After cleaning the filter:</b></p> <p>for "undercounter" models, press  to start filling (FILL).</p> <p>for hood-type models, filling (FILL) starts automatically when the hood is closed.</p>	

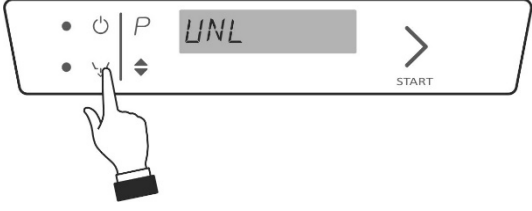
### 12.2 Total pump-out at the end of the day

The dishwasher is able to perform an automatic cleaning cycle at the end of the day.

	<p>Press the  button to start draining the appliance completely. "UNL" and the duration will appear on the display.</p> <p>The indicator <b>L2</b>  becomes blue.</p>
	<p>When finished, the dishwasher switches off.</p>

 **Never switch the dishwasher off with water in the tank; always pump out first.**

### 12.3 Topping up with regenerating salt (for models with softener)

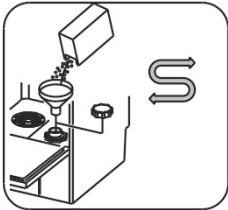
	<p><b>Warning: use specific salt only, do not use cooking sea salt.</b> Salt must be supplied when the led under the symbol indicated in the left side picture lights up. The salt container has a capacity of about <b>1 kg of granulated salt</b>.</p> <p><b>Correct procedure to refill the regenerating salt:</b></p> <ul style="list-style-type: none"> <li>- start a <b>tank pump-out</b>,</li> <li>- <b>refill the</b> regenerating salt,</li> <li>- <b>fill</b> the tank (FILL)</li> <li>- restart the <b>tank pump-out</b></li> <li>- remove any salt residues from the bottom of the tank, as it may cause corrosion/rust.</li> </ul> <p>This procedure <b>prevents</b> the washing water to enter the salt container (possible damage to the decalcifier) and that possible residues of salt are left in the tank (risk of corrosion/rust).</p>	
---	--	---

## 12.4 Routine inspection of the spray arm (once a week )

Remove the washing and rinsing (top and bottom) spray arms by unscrewing the central screw; remove the rinsing spray arms 3 and remove the screws 2 as shown. **Do not unscrew the nozzles.** Clean the holes and nozzles under a jet of clean running water; **do not use tools which might cause damage.** Reassemble the spray arms with care.

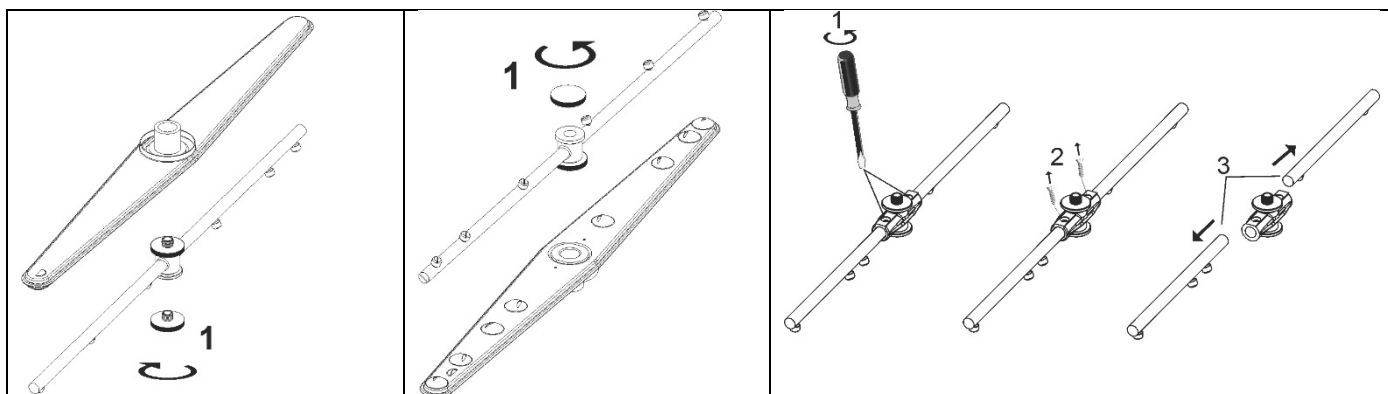

## 12.5 Lengthy periods out of use

If the dishwasher is to be out of use for a fairly long period of time, **the detergent and rinse aid dispenser devices must be emptied to prevent crystallisation and damage to the pumps:** remove the intake hoses from the detergent and rinse aid containers and place them in a container of clean water, then perform a few wash cycles followed by a complete pump-out. Finally, turn off the master switch, close the water intake valve and leave the hood ajar until the interior is completely dry. The detergent and rinse aid intake hoses must be put back into the containers when the dishwasher is returned to service, **taking care not to swap them over** (red hose = detergent, blue hose = rinse aid).

### 13 TROUBLESHOOTING

In case the pump is not working properly, follow the steps below:  
 Empty the dishwasher out using a container and disconnect the power.  
 Remove screw **A**, release tab **B** and lift it upwards.  
 Make sure that the covered drain pump impeller can rotate freely, and that there are no dirt residues, limestone, or pieces of glass. Do not use tools, screwdrivers, scissors, etc.

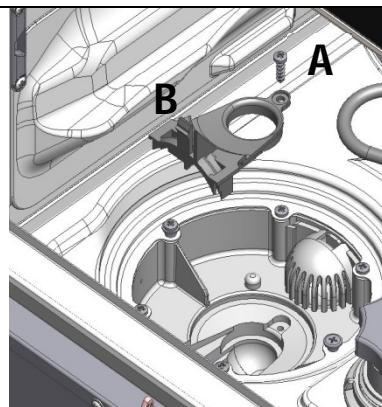

PROBLEM	POSSIBLE CAUSE	POSSIBLE SOLUTION
THE INDICATOR LIGHT <b>L1</b> DOES NOT LIGHT UP	line voltage failure	Verify electricity connection.
THE WASHING PROGRAM DOES NOT START	The dishwasher filling is not over yet.	Wait for FILL to disappear off the display
	CLOSE stays on display	If CLOSE stays even with the hood closed, contact the After-Sales Service.
POOR WASHING RESULTS	Clogged or crusted spray arms holes.	Dismount and clean the spray arms (10.2 Periodical checks)
	Clogged filter	Read "cleaning the filters during the day"
	Insufficient or improper detergent or rinse aid.	Verify detergent type and quantity.
	Failing or insufficient use of detergent or rinse aid: the detergent or rinse aid cannot be withdrawn from the dedicated containers.	Worn or broken internal tube for detergent or rinse aid of the peristaltic pump, to be replaced by the After-Sales Service. <b>This ordinary maintenance service is recommended at least once a year for the correct functioning of the dosers.</b>
	Badly positioned dishes / glasses.	Place dishes / glasses correctly.
	Low washing temperature	Verify the temperature displayed, if it is inferior than 50°C contact customer Support.

	Improper set cycle	Increase the duration of the washing cycle, especially if the load is very dirty or partially dried.
	Clogged nozzles Boiler incrustated with limescale	- Verify that the nozzles are clean and that the water softener, if present, is working correctly. - Verify that the filter of the tube placed inside the rinse aid jerrycan is not clogged.
INSUFFICIENT RINSE	Inappropriate rinse aid, or it is not dispensed correctly. Low rinsing temperature	Verify the rinse aid container and if it is adequate to the type of mains water. Verify the boiler set temperature Restore T Stop ON and/or connect the machine to hot water. If the problem is not solved, contact the After-Sales Service.
INSUFFICIENT DRYING	Inappropriate rinse aid, or it is not dispensed correctly. Water hardness superior than 12°dF or it contains many dissolved salts.	Verify the rinse aid container and if it is adequate to the type of mains water. If the problem is not solved, contact the After-Sales Service
STAINED GLASSES AND CUTLERY	Rinse aid unsuitable or not being delivered correctly. Water hardness above 12°dF or large amounts of dissolved salts	Check container of rinse aid and whether type is suitable for the mains water- If the problem persists, contact the after-sales service.
WATER LEFT IN THE TANK AFTER PUMP-OUT.	Waste tube badly positioned or partially clogged.	Verify that the tube and drainage are not clogged and that the drainage is not positioned too high; see connection scheme.

## 14 MALFUNCTIONS SHOWN ON THE DISPLAY (FOR THE USER)

The dishwasher can show a series of malfunctions on display. After the machine has been switched off and restarted, if the problem is not solved, follow the steps below:

**( FOR A MORE PROFICIENT AFTER-SALES SERVICE, ALWAYS TAKE NOTE OF THE INDICATED ERROR )**

<b>Err04</b>	Tank temperature probe anomaly	Contact After-sales Service
<b>Err05</b>	Tank water filling anomaly	Check that the water supply tap is open, the dynamic supply pressure, cleanliness of the inlet water filter. If the problem still occurs, contact After-sales Service.
<b>Err06</b>	Water pump-out anomaly (water remains in the dishwasher)	Check that the filters are clean, and that the drain pipe is not bent, obstructed, narrowed. Check that the drain pump is not blocked. If the problem still occurs, contact After-sales Service.
<b>Err09</b>	Excessive water level in the tank anomaly	Contact After-sales Service
<b>Err23</b>	Boiler heating anomaly (does not heat)	Contact After-sales Service
<b>Err24</b>	Boiler temperature probe anomaly	Contact After-sales Service
<b>Err25</b>	Boiler water filling anomaly	Check that the water supply tap is open, the dynamic supply pressure, cleanliness of the inlet water filter. If the problem still occurs, contact After-sales Service.
<b>Err26</b>	Boiler emptying anomaly	Check that the nozzles of the rinsing spray arms are not clogged. If the problem still occurs, contact After-sales Service.
<b>Err27</b>	Boiler emptying anomaly – with full tank	Contact After-sales Service

19.390.9051.02	02/05/2022
Manual rev.	Date